

kobold

VK200

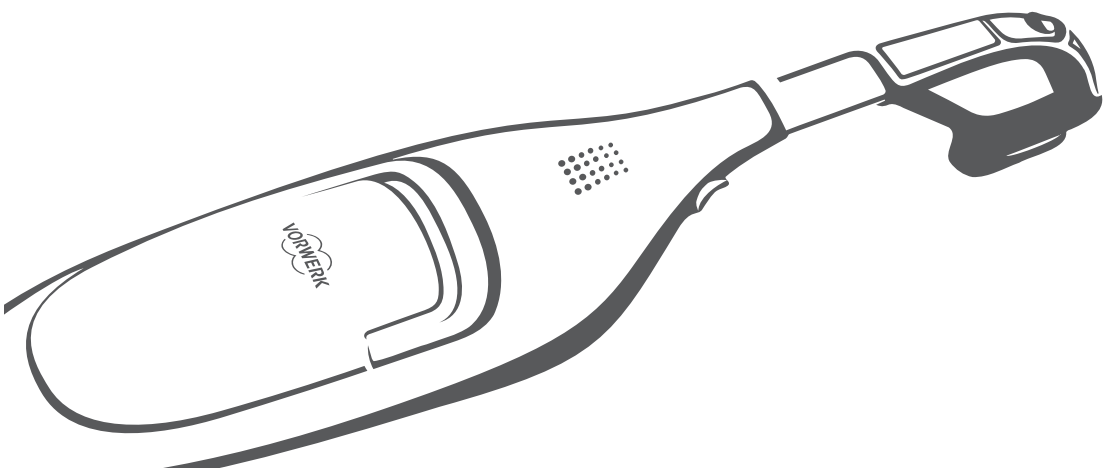

**Instruction manual
Kobold VK200
Upright Vacuum Cleaner
and accessories**

GA 25765-02 VK200 EN 1120



PRELIMINARY REMARKS

Congratulations on the purchase of your new Kobold VK200 Upright Vacuum Cleaner.

Delivering brilliant cleaning, the light and manoeuvrable Upright Vacuum Cleaner will perform for you and your home for many years to come.





Its unique and practical accessories will bring joy to cleaning your home.

BEFORE GETTING STARTED

1. Read the instruction manual carefully before using the Kobold VK200 Upright Vacuum Cleaner and accessories for the first time.
2. Keep the instruction manual for future use. It is an important part of the Upright Vacuum Cleaner and must be kept with it if you pass it on to someone else.

CHARACTERS AND SYMBOLS

The symbols which appear in this instruction manual have the following meanings:

	Warning symbols and warning notices are marked with this symbol and highlighted in grey
	Reference to Vorwerk customer service/support
	Information is marked with this symbol and highlighted in grey
	Reference to Vorwerk's Internet website

1. 2. 3. Instructions are numbered
-

VARIETY OF DIFFERENT OPTIONS AND APPLICATIONS
KOBOLD VK200 UPRIGHT VACUUM CLEANER, ACCESSORY HEADS AND ACCESSORIES

Hard floors

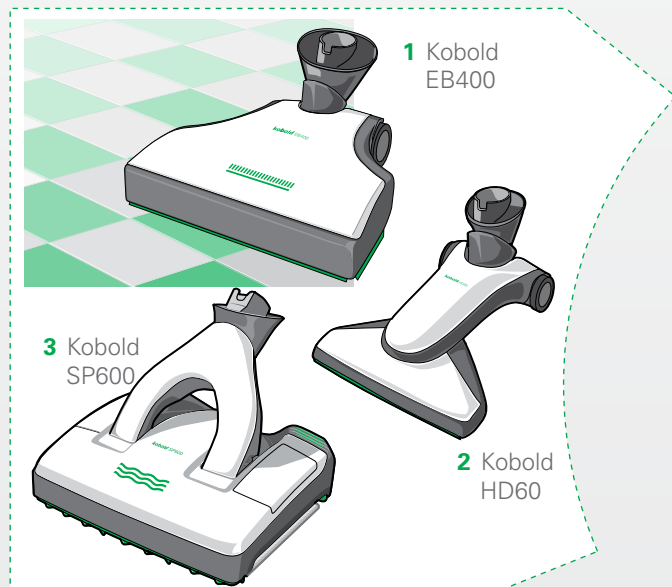

Carpet

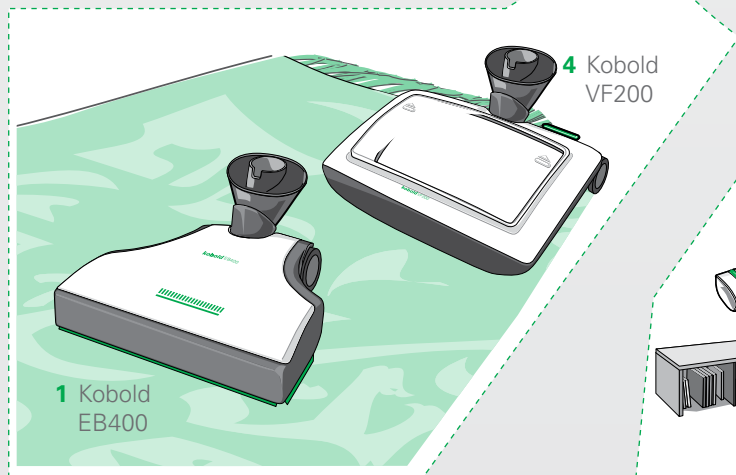

Above floor

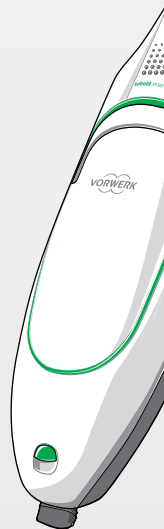
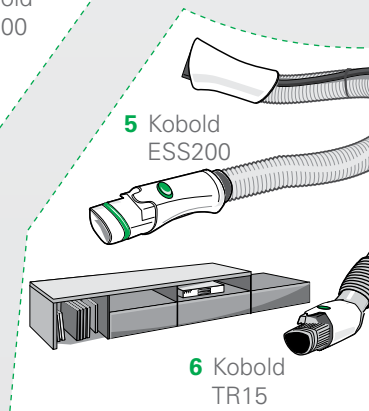



Kobold VK200

Mattresses

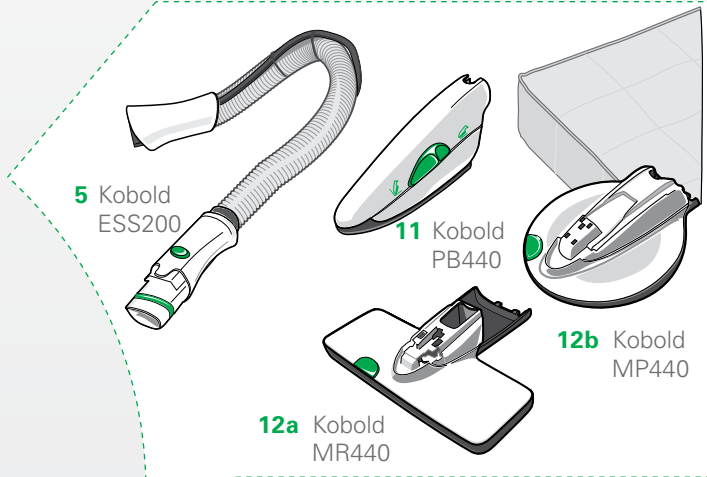

5 Kobold ESS200

11 Kobold PB440

12b Kobold MP440

12a Kobold MR440

Upholstery

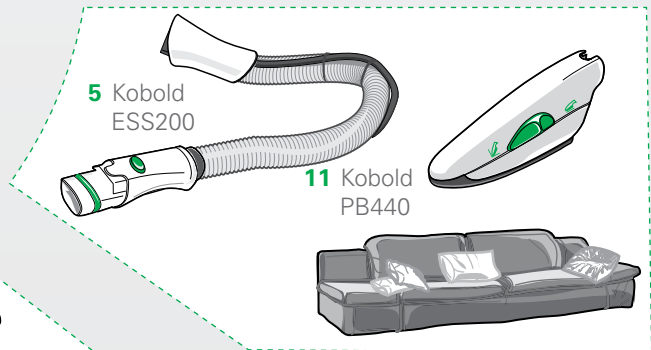

5 Kobold ESS200

11 Kobold PB440

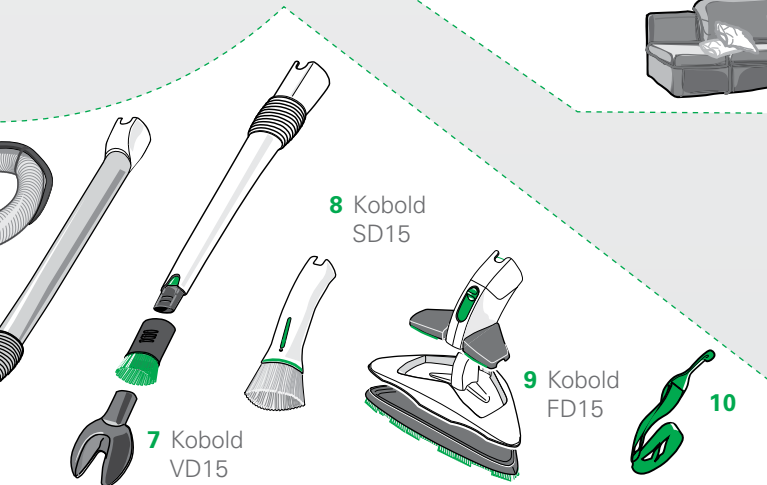

7 Kobold VD15

8 Kobold SD15

9 Kobold FD15

10

LEGEND FOR THE ACCESSORY HEADS AND ACCESSORIES

KOBOLD VK200 UPRIGHT VACUUM CLEANER

Number	Hard floors
1	Kobold EB400 Automatic Electric Brush – for vacuuming and cleaning hard floors
2	Kobold HD60 Hard Floor Nozzle – for vacuuming hard floors
3	Kobold SP600 – for vacuuming and wet cleaning hard floors
Carpet	
1	Kobold EB400 Automatic Electric Brush – for vacuuming and cleaning carpets
4	Kobold VF200 Carpet Freshener – for cleaning carpets
Above floor	
5	Kobold ESS200 Electric Suction Hose
6	TR15 Telescopic Tube
7	VD15 Variable Nozzle with Drilling Dust Attachment and Brush Tip
8	SD15 Soft Nozzle
9	FD15 Flexo Nozzle with Cleaning Brush Attachment
10	Shoulder strap
Upholstery	
5	Kobold ESS200 Electric Suction Hose
11	Kobold PB440 Electric Upholstery Brush
Mattresses	
5	Kobold ESS200 Electric Suction Hose
11	Kobold PB440 Electric Upholstery Brush
12a and 12b	The Mattress Cleaning Set with the Kobold MR440 Mattress Vacuumer and the Kobold MP440 Mattress Freshener for the Kobold PB440 Electric Upholstery Brush – for cleaning mattresses

Nature and extent of the accessories included may vary. Accessories can be purchased as options. The illustrations shown in this instruction manual are meant to illustrate the functions of the Kobold VK200 Upright Vacuum Cleaner and its accessories. The illustrations may differ with respect to detail and proportions of the actual product.

CONTENTS

1	FOR YOUR SAFETY	9	3	OPERATION	33
1.1	Intended use	9	3.1	Kobold EB400 Automatic Electric Brush ..	34
1.2	Hazard warnings	12	3.1.1	Operating display and floor mode	35
1.3	Danger levels	17	3.1.2	Intelligent floor type detection	35
2	GETTING STARTED	18	3.1.3	Manually switching between hard floor/carpet mode	36
2.1	Mounting the telescopic handle	18	3.1.4	Reactivating intelligent floor detection	36
2.2	Mains connection	19	3.1.5	Floor cleaning	36
2.2.1	Attaching the power cord	19	3.1.6	For carpet or textile flooring	39
2.2.2	How to view the video for mounting the power cord.....	20	3.1.7	Combination with older vacuum cleaner models	39
2.2.3	Winding up and unwinding the power cord.....	21	3.2	Kobold VF200 Carpet Freshener	40
2.2.4	Connecting the power cord.....	21	3.2.1	Carpet cleaning with the Kobold VF200 Carpet Freshener	40
2.3	Attaching the accessory head	22	3.2.2	Filling the dosage hopper	43
2.4	Removing and replacing the accessory head.....	22	3.2.3	Kobosan Active dosage	43
2.5	Standby position and power setting	23	3.2.4	Working in Kobosan Active	44
2.5.1	Placing the device in the standby position	23	3.2.5	Replacing the accessory head	44
2.5.2	Rolling the Kobold VK200 Upright Vacuum Cleaner	25	3.2.6	Vacuumping up Kobosan Active	45
2.5.3	Putting the device in power setting	25	3.2.7	Cleaning the Kobold VF200 Carpet Freshener after use	45
2.5.4	Hanging up on the wall	25	3.2.8	Removing old stains	47
2.6	Adjusting the handle height.....	26	3.3	Kobold SP600	48
2.7	Carrying the Kobold VK200 Upright Vacuum Cleaner	27	3.4	Accessories for the Kobold SP600	49
2.7.1	Carrying by the carry handle	27	3.4.1	Koboclean.....	49
2.7.2	Carrying by the shoulder strap.....	28	3.4.2	Kobold MF600 cleaning cloths	50
2.8	Switching the device on and off, setting the power performance level	29	3.4.3	Suitability of the Kobold MF600 cleaning cloths for diverse hard floor types.....	51
2.8.1	Switching on	29	3.4.4	Attaching the Kobold SP600	52
2.8.2	Setting the power performance level.....	29	3.4.5	Setting and releasing the standby position on the Kobold SP600	52
2.8.3	Function key	30	3.4.6	Getting the Kobold SP600 ready for use... ..	54
2.8.4	Switching off the device	30	3.4.7	Switching the SP600 on and off	58
2.9	Filter fill level indicator, filter bags, motor protection filter.....	30	3.4.8	Automatic application of moisture and dry mode	61
2.9.1	Filter bag and motor protection filter	30	3.4.9	Working with the Kobold SP600	66
2.9.2	Filter fill level indicator	31	3.4.10	After using the Kobold SP600	69
2.10	Dovina fragrance chip	32	3.5	Kobold PB440 Electric Upholstery Brush and Kobold MP440/MR440 Mattress Cleaning Set.....	70
2.10.1	Inserting the Dovina fragrance chip.....	32	3.5.1	Cleaning upholstery with the Kobold PB440 Electric Upholstery Brush	70
2.10.2	Removing the Dovina fragrance chip	32			

3.5.2	Regulating the suction force.....	71	4.5	Kobold PB440 Electric Upholstery Brush and Kobold MP440/MR440 Mattress Cleaning Set.....	97
3.5.3	Vacuumping surfaces	71	4.5.1	Kobold PB440 Electric Upholstery Brush ..	97
3.5.4	Vacuumping crevices.....	71	4.5.2	Cleaning the Kobold MP440 Mattress Freshener	98
3.5.5	Cleaning mattresses with the Kobold PB440 Electric Upholstery Brush and the Kobold MP440/MR440 Mattress Cleaning Set.....	72	4.5.3	Cleaning the Kobold MR440 Mattress Vacuumer	99
3.5.6	Removing the Kobold PB440 Electric Upholstery Brush Suction Nozzle	73	4.6	Additional accessories	99
3.5.7	Cleaning mattresses.....	74	5	TROUBLESHOOTING	100
3.5.8	Cleaning the Mattress Freshener MP440 and Mattress Vacuumer MR440 after use..	76	5.1	Kobold VK200 Upright Vacuum Cleaner	100
3.6	Kobold HD60 Hard Floor Nozzle	77	5.2	Kobold EB400 Automatic Electric Brush.....	103
3.6.1	Use.....	77	5.3	Kobold VF200 Carpet Freshener	105
3.7	Kobold ESS200 Electric Suction Hose	78	5.4	Kobold SP600.....	106
3.7.1	Attaching the Kobold ESS200 Electric Suction Hose.....	78	5.5	Kobold PB440 Electric Upholstery Brush	112
3.8	Additional accessories	79	5.6	Kobold FD15 Flexo Nozzle.....	113
3.8.1	Kobold TR15 Telescopic Tube	79	6	DISPOSAL AND ENVIRONMENTAL PROTECTION.....	114
3.8.2	Kobold VD15 Variable Nozzle.....	81	6.1	Disposal of the device.....	114
3.8.3	Kobold SD15 Soft Nozzle.....	82	6.2	Disposing of the packaging.....	114
3.8.4	Kobold FD15 Flexo Nozzle.....	83	6.3	Information on environmental protection.....	115
3.8.5	Kobold FD15 Flexo Nozzle – complete	83	6.3.1	Less packaging	115
3.8.6	Kobold FD15 Flexo nozzle – top part	83	6.3.2	Saving energy.....	115
3.8.7	Kobold FD15 Flexo nozzle – folded	84	6.3.3	Environmentally friendly production	115
3.8.8	Cleaning plate.....	84	6.3.4	Reusable material.....	115
4	MAINTENANCE	85	7	WARRANTY	116
4.1	Spare parts and consumables.....	86	8	SERVICES.....	116
4.2	Maintaining the Kobold VK200 Upright Vacuum Cleaner	87	9	TECHNICAL SPECIFICATIONS	117
4.2.1	Changing the Kobold FP200 3in1 Premium Filter Bag	87	9.1	Manufacturer	121
4.2.2	Cleaning and/or replacing the Kobold VK200 motor protection filter.....	89			
4.2.3	Removing the power cord from the Kobold VK200 Upright Vacuum Cleaner....	91			
4.3	Kobold EB400 Automatic Electric Brush..	92			
4.3.1	Checking and cleaning.....	92			
4.3.2	Taking out the brush to clean or replace it.....	93			
4.4	Kobold SP600	95			
4.4.1	Checking and cleaning the sealing lip frames	96			
4.4.2	Cleaning the tank.....	96			

SUITABILITY OF THE ACCESSORY HEADS FOR FLOORS

Carpet type	Kobold EB400	Kobold VF200	Kobold SP600	Kobold HD60
Loop-pile carpet				
Velour carpet	++	++	-	-
Berber carpet				
Deep-pile carpet (< 1.5 cm)				
Light rugs	+	-	-	-
Silk carpets				
Sisal flooring				
Fur				
Flokati				
Loosely woven carpets	-	-	-	-
Carpets with long interwoven fibres (Saxony)				
Hard floor type				
Sealed/varnished wooden floors (floorboards, parquet)	++	-	++	+
Oiled/waxed wooden floors	+	-	++	+
Unsealed/untreated wooden floors	-	-	•	+
Sealed cork floors	++	-	++	+
Oiled/waxed cork floors	+	-	•	+
Unsealed/untreated cork floors	-	-	•	+
Laminate	++	-	++	+
Elastic flooring (PVC, cushion vinyl, linoleum)	+	-	++	+
Stone floors (marble, granite, Jura limestone, artificial stone)	+	-	++ ¹⁾	+
Porous/delicate natural stone (slate, clinker tiles)	-	-	+ ¹⁾	+
Clay floors (terracotta, clinker, brick clay tiles)	+	-	++ ¹⁾	+
Ceramic glazed tiles and fine stoneware	++	-	++	+
Untreated tiled floors	-	-	•	+
Rough concrete flooring (washed concrete)	-	-	-	+

1) Only with cleaning cloth Kobold MF600 Universal Soft.

++ excellent suitability

- not suitable

+ very good suitability

• Only for dry cleaning with cleaning cloth Kobold MF600 Dry. No wet cleaning.

Note!

Follow the detailed application instructions in the following chapters.

1 FOR YOUR SAFETY

Safety is at the forefront of all Vorwerk products. The product safety of the Kobold VK200 Upright Vacuum Cleaner and its accessories can however only be ensured if this chapter is followed.

1.1 INTENDED USE

Note!

This appliance can be used by children aged from 8 years and above and persons with reduced physical, sensory or mental capabilities or lack of experience and knowledge if they have been given supervision or instruction concerning use of the appliance in a safe way and understand the hazards involved.

Children shall not play with the appliance. Cleaning and user maintenance shall not be carried out by children without supervision.

KOBOLD VK200 UPRIGHT VACUUM CLEANER

The Upright Vacuum Cleaner is solely intended for removing dust within domestic areas. This also includes use for typical household applications in shops, offices and similar work environments, agricultural operations, by customers in hotels, motels and similar living environments and in bed and breakfast operations.

The Upright Vacuum Cleaner may only be used with the corresponding Vorwerk accessories.

- To find out what types of carpet and hard floors the accessory heads are suitable for, please refer to the table “Suitability of the accessory heads for floors” on page 8.

KOBOLD EB400 AUTOMATIC ELECTRIC BRUSH

The Automatic Electric Brush may only be used in combination with a Kobold vacuum cleaner. It is intended only for the care of floors and carpets.

The Automatic Electric Brush is intended only for the types of carpet and hard flooring specified in the table “Suitability of the accessory heads for floors” on page 8.

The following carpet and flooring types must **not** be cleaned with the Automatic Electric Brush: Fur/skins, flokati rugs, carpets with long interwoven fibres (Saxony), loosely knotted or loosely woven carpets, thick deep-pile carpets, unsealed cork floors, unsealed soft wood floors, Belgian granite, sensitive natural stone floors, rough concrete floors (e.g. exposed aggregate concrete).

KOBOLD VF200 CARPET FRESHENER

The Carpet Freshener may only be used in combination with a Kobold vacuum cleaner. It is intended only for the care of carpets and rugs.

The Carpet Freshener is intended only for the types of carpet specified in the table “Suitability of the accessory heads for floors” on page 8.

The following carpet types must **not** be cleaned with the Carpet Freshener: deep-pile carpets >1.5 cm, fur rugs, flokati rugs, carpets with long interwoven fibres (Saxony), loosely knotted or loosely woven carpets, silk carpets.

KOBOLD SP600

The SP600 may only be used in combination with a Kobold vacuum cleaner. Your Kobold SP600 should be used solely for cleaning hard floors in domestic areas. Only operate the device on mains voltage of 220 to 240 volts. It is only intended for use on the types of hard floors specified on page 8. It is suitable for use on any floors that can be wet cleaned according to the manufacturer's recommendations. The following types of flooring must **not** be wet cleaned: untreated cork flooring, untreated tiled flooring, untreated soft wood flooring.

KOBOLD PB440 ELECTRIC UPHOLSTERY BRUSH

The Electric Upholstery Brush may only be used in combination with a Kobold vacuum cleaner and the corresponding Electric Suction Hose. It is intended only for the care of upholstered furniture and stairs.

KOBOLD MP440/MR440 MATTRESS CLEANING SET

The Mattress Cleaning Set may only be used in combination with a Kobold vacuum cleaner and the Kobold Electric Upholstery Brush. It is intended only for the care of mattresses.

KOBOLD HD60 HARD FLOOR NOZZLE

The Hard Floor Nozzle may only be used in combination with a Kobold vacuum cleaner. The Hard Floor Nozzle is intended only for the care of smooth hard floors in the home.

1.2 HAZARD WARNINGS

Note!

- Read the instruction manual carefully before using the Kobold VK200 Upright Vacuum Cleaner and accessories for the first time.
- Observe the following notes in particular.
- Keep the instruction manual for future use. It is an important part of the Upright Vacuum Cleaner and must be kept with it if you pass it on to someone else.

Risk of electric shock!

- Always switch the device off and disconnect the mains plug before all retrofitting, cleaning and maintenance work.
- Turn off the device by using the switch on the Kobold VK200 Upright Vacuum Cleaner handle and then disconnect the mains plug before leaving the device unattended.
- Never pull the mains plug from the socket by the power cord, only by the plug.
- Do not vacuum liquids, damp dirt or damp floor mats or carpets.
- Do not use the device in damp environments.
- Do not use the electrical accessories on wet surfaces or outdoors under any circumstances.
- Never use water, wet cleaning agents or a damp cloth to clean your device or electrical accessories, especially the electrical connections of the Kobold ESS200 Electric Suction Hose.
- Never drive over the power cord or other cables on the floor when using the motorised accessory heads, the Kobold EB400 Automatic Electric Brush or the Kobold SP600.

- The Kobold SP600 is only suitable for use on floors. Only clean horizontal surfaces with the Kobold SP600.
- Never perform repairs on your device yourself. Repairs to electric appliances may only be carried out by your authorised Vorwerk Customer Service Centre.
- Do not insert any pointed objects into the electrical contacts.
- Do not modify the electrical contacts.
- Never carry the device by the power cord.
- Do not continue using the Kobold VK200 Upright Vacuum Cleaner, the electrical accessory heads or the power cord if they become damaged.
- Ensure that the inspection flap of the Kobold SP600 is kept free of dirt.
- For your own safety, turn off the vacuum cleaner using the switch on the handle every time you replace the Kobold MF600 cleaning cloth.
- Never pour any liquid over the device and never hold it under running water.
- Should water get into the device, ensure that both the Kobold VK200 Upright Vacuum Cleaner and the accessory head are completely dry before using them again.
- In case of damage, contact your Vorwerk Customer Service Centre.

Warning! The Kobold ESS200 Electric Suction Hose has electrical connections.

- Do not use it to vacuum water.
- Do not submerge in water for cleaning purposes.
- The hose must be checked regularly and should not be used if damaged.

Fire hazard!

- Do not vacuum glowing ash or burning cigarettes.

Risk of burning!

- Do not pour hot or boiling water into the tank of the Kobold SP600.

Explosion hazard!

- Do not vacuum up explosive or readily inflammable substances.
- Do not use oil-based cleaning agents, cleaning agents containing irritants, solvents or chlorine, or flammable cleaning agents and, in particular, do not pour these into the tank of the Kobold SP600.
- Never mix different cleaning agents and care products.

Choking hazard due to swallowing small parts!

- Regularly check the condition of the cleaning cloth and replace it with a new one if required.
- Keep small parts, such as Dovina fragrance chips and the cover of the inspection opening on the Kobold HD60 Hard Floor Nozzle, out of the reach of children.

Risk of injury due to negative pressure!

- Do not vacuum any body parts. Do not vacuum near children or pets.
- Do not vacuum hair on the head.

Risk of injury!

- The inspection flap on the Kobold SP600 is closed using a magnet. Keep the magnet away from pacemakers, internal defibrillators and other active implants. Alert those concerned.

Pinching hazard!

- Keep clear of the moving parts on the accessory heads.

Loss of suitability for allergy sufferers!

- Use original Kobold filters and filter bags only.
Do not re-use spent filter bags.

Risk of injury due to sharp fragments of plastic!

- Do not use the device if plastic components have been damaged due to falling or impacts. Protect yourself against fragments with sharp edges.

Caution! Risk of falling and causing injury!

- The Kobold VK200 Upright Vacuum Cleaner with the accessory head in standby position must be placed on a level surface.
- Never use the Kobold VK200 Upright Vacuum Cleaner to support yourself.
- Never stand on the accessory heads.

Note! Risk of damage from improper use!

- Only use original Kobold products.
- Only operate the device with alternating current voltage on a connection properly installed by a qualified electrician.
- Only operate the device with the alternating current voltage stated on the type plate.
- The Kobold motor protection filter must be installed to operate the device.
- Only use the device with an original FP200 3in1 Premium Filter Bag.
- Never use the Kobold SP600 without the cleaning cloth.



- Before switching on the device, make sure that there are no small stones, granulates such as cat litter or other pointed or sharp-edged objects under the cleaning cloth.
- Never work on the same spot for more than 10 seconds.
- Never leave the Kobold SP600 standing on the floor with a wet cleaning cloth for a long period of time (more than 30 seconds). This can cause damage to delicate flooring.
- Only use original Kobold cleaning agents. When working with the Kobold SP600, never use acid cleaning agents (e.g. vinegar-based cleaner) or highly alkaline cleaning agents (e.g. chlorine bleaching).
- Do not pour any cleaning agents or care products containing polymers into the tank of the Kobold SP600.
- For delicate floors, such as floors which are not permanently sealed (oiled cork, oiled parquet, coated, oiled stoneware), we recommend that you first test the device in an inconspicuous area to prevent damage to the floor.
- Do not apply any moisture when using the Kobold MF600 Dry cleaning cloth.
- Keep credit cards, electronic storage media and other objects that are sensitive to magnetic fields away from the magnetic inspection flap on the Kobold SP600.

The device complies with the safety regulations of the country where it was sold by an authorised Vorwerk organisation. If the device is used in a different country, compliance with local safety standards cannot be guaranteed. Therefore, Vorwerk assumes no liability for resulting safety risks for the user.

1.3 DANGER LEVELS

1. For your safety, please observe the hazard warnings in the chapters that follow.

You can identify the hazard warnings in the following chapters by the warning symbol and/or a signal word indicating a danger level:

Danger level	Warning symbol	Signal word	Possible risks
3		WARNING	<ul style="list-style-type: none">– Risk of electric shock– Fire hazard– Explosion hazard
2		CAUTION	<ul style="list-style-type: none">– Risk of injury
1		NOTE	<ul style="list-style-type: none">– Risk of damage from improper use– Property damage from improper use

2 GETTING STARTED

In this chapter you will learn how to set up your Kobold VK200 Upright Vacuum Cleaner for use. You will get to know the basic functions of your Upright Vacuum Cleaner and how to use it properly.

2.1 MOUNTING THE TELESCOPIC HANDLE

The telescopic handle is not attached to the Kobold VK200 Upright Vacuum Cleaner on delivery. Proceed as follows to attach the telescopic handle to the Upright Vacuum Cleaner:

i It is recommended to attach an accessory head before inserting the telescopic handle. For instructions on mounting an accessory head, see chapter "2.3 Attaching the accessory head" on page 22.

1. Fully unfold the clamping lever **3** and hold it.
2. Insert the telescopic handle **1** into the opening **2** of the Upright Vacuum Cleaner as far as the stop point, where you will feel it engage.
3. Close the clamping lever **3**.

Now the telescopic handle is firmly secured to the Upright Vacuum Cleaner and cannot be released.

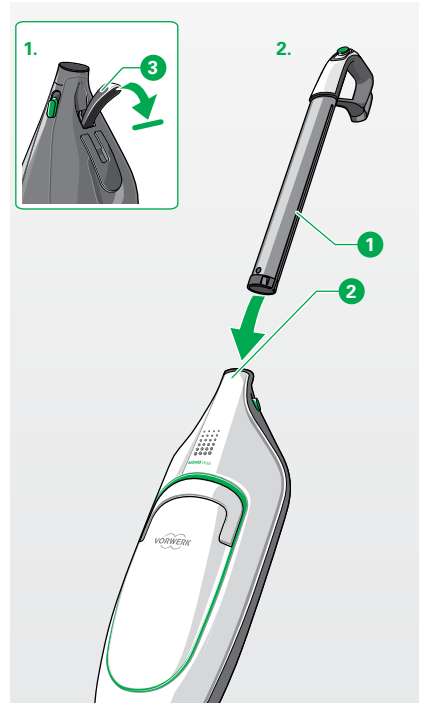

2.2 MAINS CONNECTION

2.2.1 ATTACHING THE POWER CORD







WARNING

Risk of electric shock!

Disconnect the plug from the mains socket before attaching the power cord.

 A yellow collar is included with your Kobold VK200 Upright Vacuum Cleaner. Please follow the below instructions to attach the power cord correctly.

Before using the Kobold VK200 Upright Vacuum Cleaner for the first time, attach the power cord as follows:

1. Fully unfold the clamping lever .
Pull the telescopic handle  out slightly.
Push up on the clamping lever  to secure the handle in place.
2. Feed the power cord  through the opening at the end of the telescopic handle with the clip facing to the left.
Thread the power cord in slightly.
The cord will visibly run down the length of the handle to the base where it meets the main body of the VK200 Upright Vacuum Cleaner.
3. Secure the yellow collar  above the power cord  on the telescopic handle.
The arrow on the yellow collar should be facing downwards.

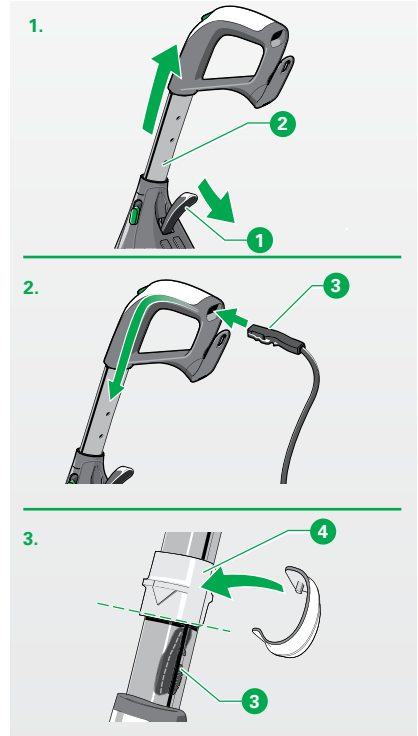

4. Fully unfold the clamping lever **1** again. Hold it in the downward position. Using the handle, push the yellow collar **4** down towards the vacuum cleaner. Push down firmly on the handle until you hear an audible 'click'.
5. Remove the collar **4**.
6. Slide the telescopic handle down fully into the Upright Vacuum Cleaner.
The power cord is now correctly inserted and the VK200 Upright Vacuum Cleaner is ready for use.

i Once it is inserted, leave the power cord in the device permanently. Only remove the power cord if you need to replace it (see "4.2.3 Removing the power cord from the Kobold VK200 Upright Vacuum Cleaner" on page 91).

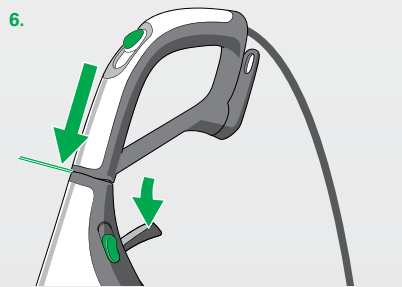
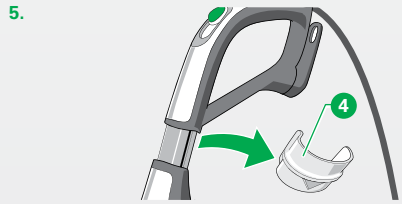
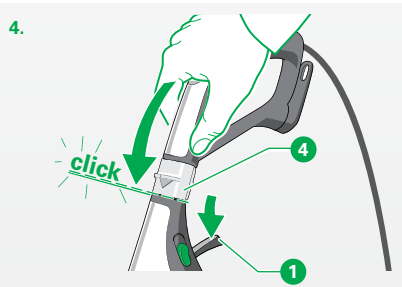

2.2.2 HOW TO VIEW THE VIDEO FOR MOUNTING THE POWER CORD

To view this procedure online, please scan the QR code with your smartphone or tablet which will take you to an instructional video.

Or visit

www.kobold-worldwide.com/vk200/



2.2.3 WINDING UP AND UNWINDING THE POWER CORD

WARNING

Risk of electric shock!

- Pull the mains plug from the socket before winding up the power cord!

CAUTION

Danger of damaging electrical parts!

- Make sure the device and power cord are not damaged during winding up.

Wind up the power cord when you have finished using the Upright Vacuum Cleaner.

1. Wind the power cord **1** around the cable hook **3** on the Upright Vacuum Cleaner and around the cable hook on the handle **2**.

Unwind the power cord when you want to use the Upright Vacuum Cleaner.

2. To unwind the power cord, turn the cable hook **2** to the side (I.)
The power cable is released from the cord wrap.
3. Now turn the cable hook **2** back to the vertical position.

2.2.4 CONNECTING THE POWER CORD

1. Connect the mains plug to the socket.

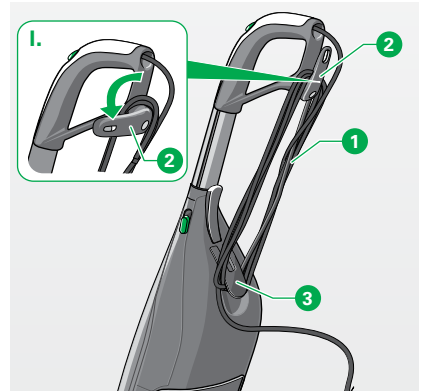

2.3 ATTACHING THE ACCESSORY HEAD

You can use the following accessory heads to clean your floor:

- Kobold EB400 Automatic Electric Brush
- Kobold VF200 Carpet Freshener
- Kobold SP600
- Kobold HD60 Hard Floor Nozzle

The attachment process is the same for all four accessory heads:

1. Connect the attachment socket **1** of the Upright Vacuum Cleaner to the pivot on the accessory head **2**.
2. Make sure you hear the attachment socket click into the pivot.

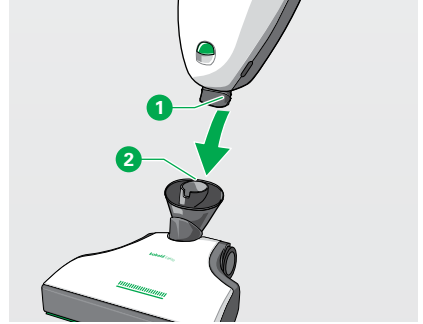

2.4 REMOVING AND REPLACING THE ACCESSORY HEAD

To remove the accessory head from your Kobold VK200 Upright Vacuum Cleaner, you have two options:

1. Unlock the accessory head at the top of the telescopic handle by sliding the switch **1** up.

or

2. Push the switch at the bottom of the suction port **2** up to unlock the accessory head **3**.

Once it is unlocked, you can remove the accessory head from the Upright Vacuum Cleaner.



2.5 STANDBY POSITION AND POWER SETTING

In combination with an accessory head, you can either use your Kobold VK200 Upright Vacuum Cleaner in the power setting or place it in the standby position.

2.5.1 PLACING THE DEVICE IN THE STANDBY POSITION

CAUTION

Risk of falling and causing injury!

The standby position is used to park the device after you have finished working with it or when you take a break.

- The Kobold VK200 Upright Vacuum Cleaner with the accessory head in standby position must be placed on a level surface.
- Never use the Kobold VK200 Upright Vacuum Cleaner to support yourself.
- Never stand on the accessory heads.

NOTE

Risk of damage when the device starts up automatically.

- Note that the Kobold VK200 Upright Vacuum Cleaner starts up automatically when you take it out of the standby position if you have not first switched off the mains switch.

The standby position is used to store your Upright Vacuum Cleaner when you are not using it. You can also “park” it in this position if you want to take a short break while cleaning. In the standby position, the device stands upright and firmly on the floor.

You can only place the Upright Vacuum Cleaner in standby position when it is centred.

1. To centre it, turn both the Upright Vacuum Cleaner and the accessory head, e.g. the Automatic Electric Brush **1**, at the pivot to face straight ahead. *Now you can place it in the standby position.*
2. Move the telescopic handle forward **2** until it stands upright and you can hear it click into the pivot **3**.
3. If you will not be using your Upright Vacuum Cleaner for some time, disconnect the mains plug and store the device properly.

i If you put the Kobold VK200 Upright Vacuum Cleaner with the Kobold EB400 Automatic Electric Brush, the Kobold VF200 Carpet Freshener or the Kobold SP600 into the standby position and have not switched it off via the main switch, the Upright Vacuum Cleaner automatically switches off the fan, and the brush of the EB400/VF200 or the cloth holder of the SP600 will stop. The filter fill level indicator and the control lights of the accessory head stay lit.

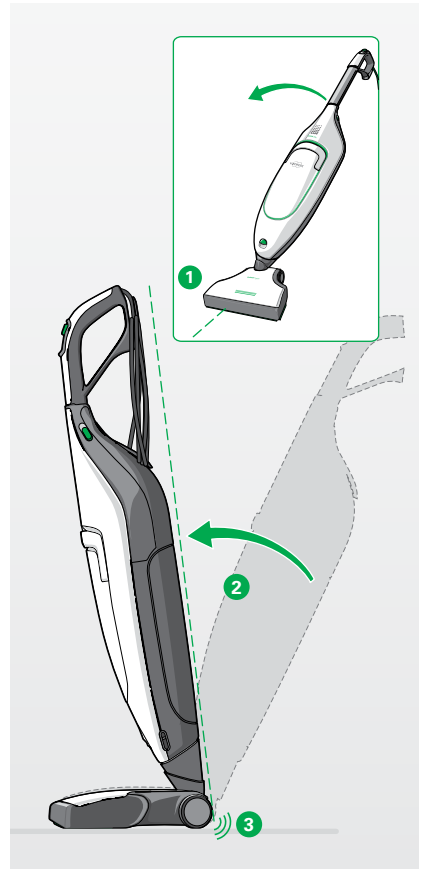

2.5.2 ROLLING THE KOBOLD VK200 UPRIGHT VACUUM CLEANER

You can conveniently roll the device in the standby position ① to freely move it:

1. In the standby position, tilt the device backwards ② so it stands on the rollers.
2. Move it in the desired direction on the rollers ③.



2.5.3 PUTTING THE DEVICE IN POWER SETTING

In the power setting, the Upright Vacuum Cleaner can be moved freely and the device can be steered in all directions on the floor.

1. Hold the accessory head firmly in place with your foot ① and tilt the telescopic handle back ② so that you hear it disengage from the standby position.

Now the accessory head can be moved in all directions again.

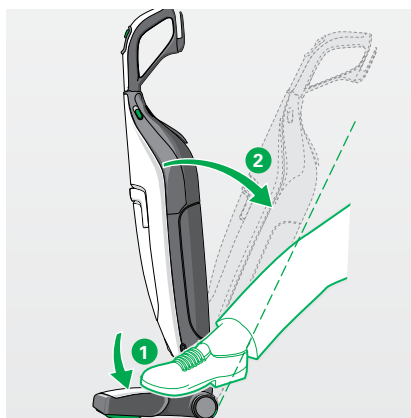

2.5.4 HANGING UP ON THE WALL

You can hang the Upright Vacuum Cleaner on the wall to store it.

1. Leave the device in the power setting.
2. With the upper opening of the cable hook ③, hang the device on the wall.

The accessory head hangs down ②.

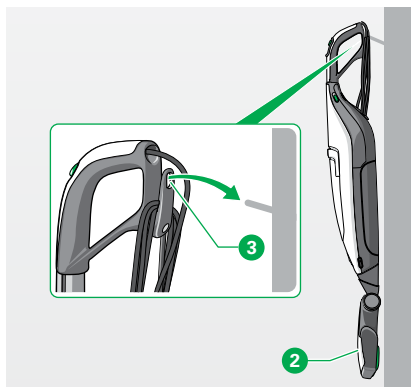

2.6 ADJUSTING THE HANDLE HEIGHT

CAUTION

Danger of damaging electrical parts!

- Make sure that the power cord is able to move freely in the cable channel when adjusting the handle.
- Do not hold the power cord whilst adjusting the handle.
- Ensure that the power cord does not get jammed inside the cable channel of the handle.

1. Unfold the clamping lever **1** as far as it will go and hold it.
2. Set the adjustable handle **2** to the desired height.
3. Close the clamping lever **1** to lock the adjustable handle **2**.
4. Push or pull slightly on the adjustable handle **2** until you hear a click.
Now the adjustable handle is firmly locked and ready for use.
5. To store the Upright Vacuum Cleaner (or to use it for cleaning higher than floor level), set the adjustable handle to the lowest position.

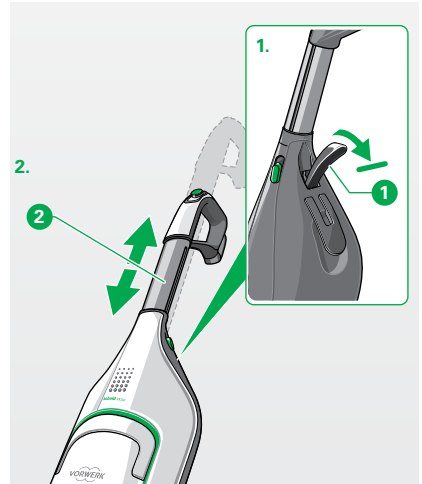

2.7 CARRYING THE KOBOLD VK200 UPRIGHT VACUUM CLEANER

WARNING

Risk of electric shock!

- Never carry the Kobold VK200 Upright Vacuum Cleaner by the power cord.

1. Before carrying the device, push the adjustable handle all the way in.

2.7.1 CARRYING BY THE CARRY HANDLE



CAUTION

Risk of injury if the carry handle is not locked!

If the carry handle does not properly lock in the carrying position, your fingers may get pinched.

- Make sure the carry handle engages properly before you carry the Kobold VK200 Upright Vacuum Cleaner.

To carry the Upright Vacuum Cleaner by the carry handle, proceed as follows:

1. Lift the carry handle  away from the vacuum cleaner.
2. Pull the carry handle  up.
3. When you release the carry handle, a spring pulls it back into its original position.

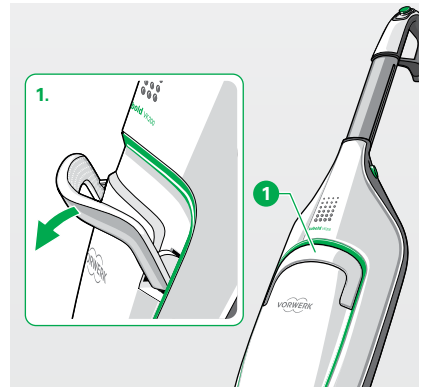

2.7.2 CARRYING BY THE SHOULDER STRAP

NOTE

Risk of damage due to falling!

The shoulder strap could come loose, causing the Kobold VK200 Upright Vacuum Cleaner to be dropped.

- Make sure that the carry strap is securely attached to the Upright Vacuum Cleaner and the eyelet on the handle.

To use the Upright Vacuum Cleaner in areas above floor level, you can carry it using the shoulder strap:

1. Hook one end of the shoulder strap **1** into the eyelet on the handle **2**.
2. Hook the other end of the shoulder strap into one of the two eyelets **3** on the side of the Upright Vacuum Cleaner.

i The shoulder strap is available separately and is not included with the Kobold VK200 Upright Vacuum Cleaner on delivery.

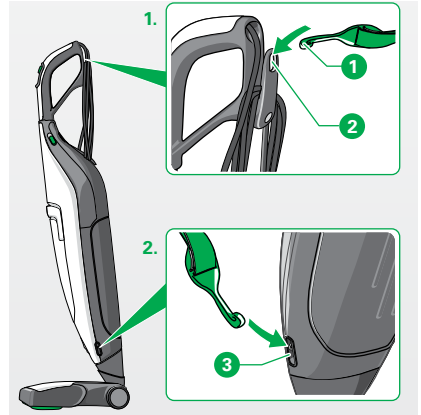

2.8 SWITCHING THE DEVICE ON AND OFF, SETTING THE POWER PERFORMANCE LEVEL

2.8.1 SWITCHING ON

1. Switch the Kobold VK200 Upright Vacuum Cleaner on by sliding the main switch **1** from position **2** forwards **3**.

2.8.2 SETTING THE POWER PERFORMANCE LEVEL

In general, we recommend power performance level auto (automatic suction power).

i When the Kobold EB400 Automatic Electric Brush is used, the suction power is regulated automatically if the power performance level 'auto' has been set using the main switch **1**.

1. To manually set the suction power levels with the main switch **1**, proceed as follows:

auto automatic suction power (recommended)
soft minimum power
med medium power
max maximum power

i We recommend vacuuming with the power performance level auto when using all accessory parts. The other power levels are specially intended for specific uses. You will find these in the chapters on the accessory parts.

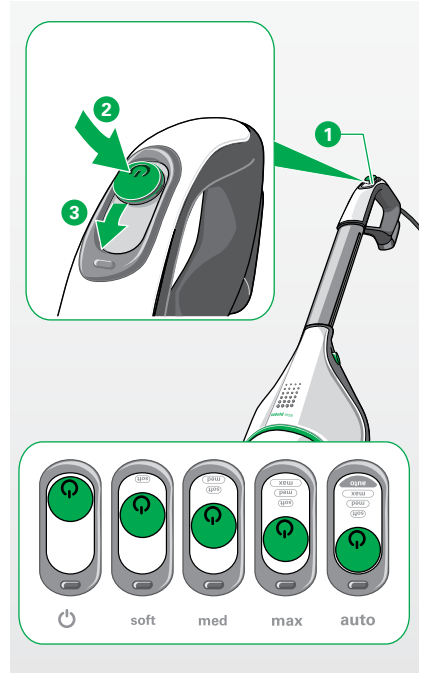

2.8.3 FUNCTION KEY



The function key **1** is only active when using the Kobold EB400 Automatic Electric Brush or the Kobold SP600.

FUNCTION KEY WITH THE KOBOLD EB400 AUTOMATIC ELECTRIC BRUSH

The chapter “3.1.1 Operating display and floor mode” on page 35 tells you how to set the floor detection function and switch between floor types using the function key.

FUNCTION KEY WITH THE KOBOLD SP600

The chapter “3.4.8 Automatic application of moisture and dry mode” on page 61 tells you how you can control the level of moisture on the Kobold SP600.

2.8.4 SWITCHING OFF THE DEVICE

1. To switch the Upright Vacuum Cleaner off, slide the main switch all the way back.

2.9 FILTER FILL LEVEL INDICATOR, FILTER BAGS, MOTOR PROTECTION FILTER

2.9.1 FILTER BAG AND MOTOR PROTECTION FILTER

The FP200 3in1 Premium Filter Bag and the motor protection filter are already installed in your Upright Vacuum Cleaner on delivery. See section “4 Maintenance” on page 85 to find out how to change the 3in1 Premium Filter Bag (chapter “4.2.1 Changing the Kobold FP200 3in1 Premium Filter Bag” on page 87) and how to replace or clean the motor protection filter (chapter “4.2.2 Cleaning and/or replacing the Kobold VK200 motor protection filter” on page 89).

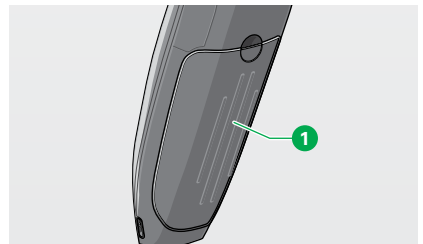
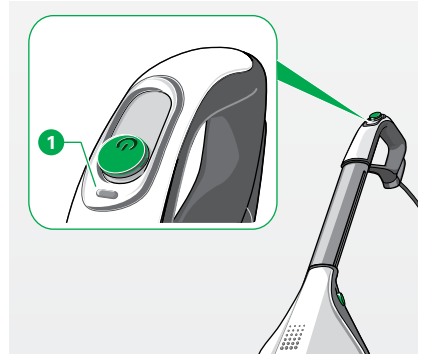

The filter cover ① of the Upright Vacuum Cleaner is equipped with a cover lock. It cannot be closed unless a 3in1 Premium Filter Bag is installed.

NOTE

Risk of damage due to closing the filter cover by force.

- Do not use force to close the filter cover.
- Only use the device with a correctly inserted, original FP200 3in1 Premium Filter Bag from Vorwerk.

2.9.2 FILTER FILL LEVEL INDICATOR

The filter fill level indicator ① with six rows of lights tells you when you need to replace the 3in1 Premium Filter Bag or if there is a fault:



Filter fill level indicator	Status of the FP200 3in1 Premium Filter Bag
All rows lit up green.	The filter bag is empty.
4 or 2 rows lit up green.	Filter bag is filling up (replacement not yet required).
All rows lit up yellow.	Filter bag must be replaced (see chapter "4.2.1 Changing the Kobold FP200 3in1 Premium Filter Bag" on page 87).
All rows flashing red.	Fault (see chapter "5 Troubleshooting" on page 100).

2.10 DOVINA FRAGRANCE CHIP



CAUTION

Choking hazard due to swallowing small parts!

- Keep small parts such as Dovina fragrance chips out of the reach of children.

2.10.1 INSERTING THE DOVINA FRAGRANCE CHIP

1. Take the Dovina fragrance chip out of the packaging.
2. Open the flap **1** of the Dovina chamber on the Upright Vacuum Cleaner.
3. Insert the Dovina fragrance chip **2** as far as it will go, with the wider side on the inner side of the flap.
4. Make sure that the Dovina fragrance chip **2** sits behind the tab **3**.
5. Close the flap **1**.

2.10.2 REMOVING THE DOVINA FRAGRANCE CHIP

1. Open the flap **1** of the Dovina chamber on the Upright Vacuum Cleaner.
2. Hold the left and right side of the Dovina fragrance chip and pull it away from the flap to remove it.
3. Used Dovina fragrance chips can be disposed of in household waste.

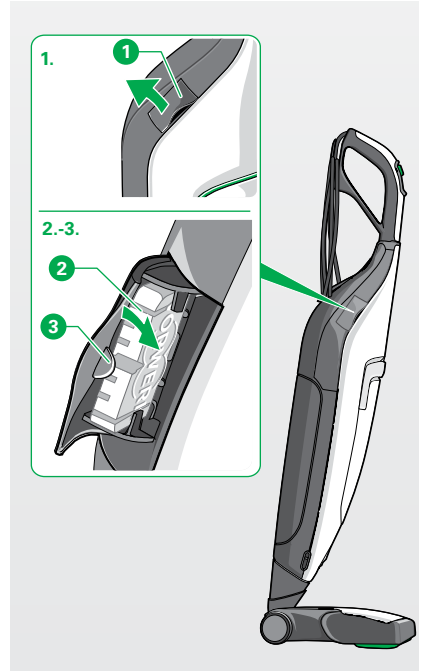

3 OPERATION

Depending on the accessory head or accessories you are using, continue with one of the following chapters:

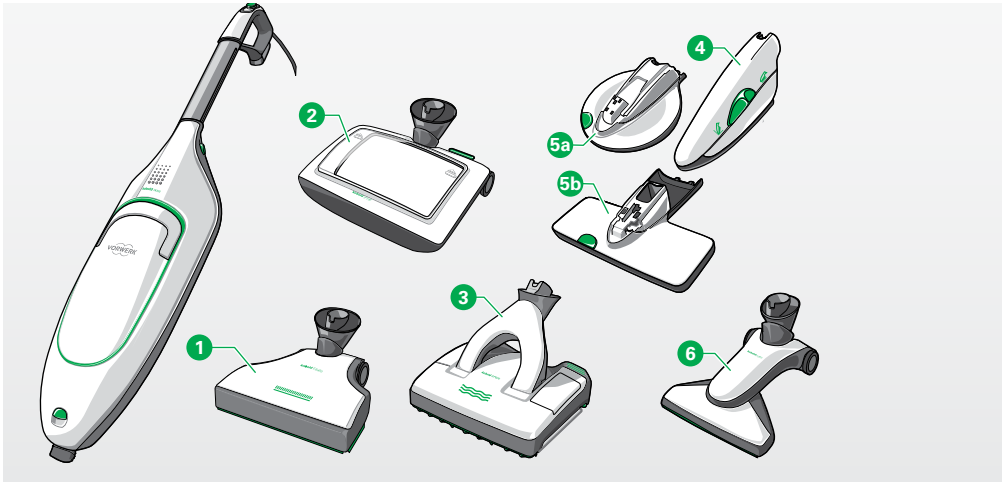

	Accessory head	Application	Chapter/page
1	Kobold EB400 Automatic Electric Brush	Vacuuming and cleaning carpets and hard floors	page 34
2	Kobold VF200 Carpet Freshener	Cleaning carpets with Kobosan Active	page 40
3	Kobold SP600	Vacuuming and wet cleaning hard floors	page 48
4	Kobold PB440 Electric Upholstery Brush	Vacuuming upholstery surfaces and recesses	page 70
5a 5b	Kobold PB440 Electric Upholstery Brush combined with Kobold MP440/MR440 Mattress Cleaning Set	Cleaning and vacuuming mattresses with Lavenia	page 70
6	Kobold HD60 Hard Floor Nozzle	Vacuuming smooth hard floors	page 77
	Additional accessories	Vacuuming surfaces, corners, joints etc. of furniture	page 79

3.1 KOBOLD EB400 AUTOMATIC ELECTRIC BRUSH

The Automatic Electric Brush performs equally well on carpets and hard floors. For especially thorough carpet cleaning, the Automatic Electric Brush has its own motor that drives the integrated roller brush. The diagram shows the Automatic Electric Brush and its operating elements.

The Automatic Electric Brush with its versatile functionality can be used on most floors.

1. Nevertheless, please make sure that the Automatic Electric Brush is suitable for your floor before using it (see table on page 8).

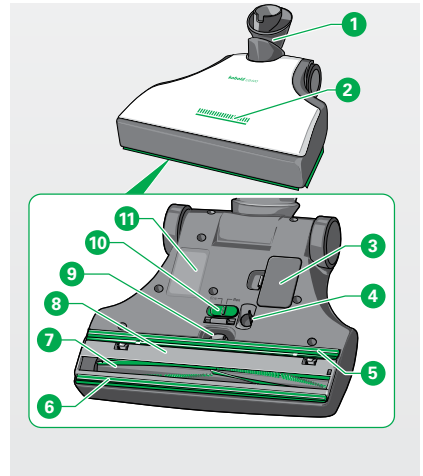

WARNING

Risk of electric shock!

- Never drive your Kobold EB400 Automatic Electric Brush over the power cord or other cables on the floor.

CAUTION

Pinching hazard!











- Stay clear of the moving parts on the Kobold EB400 Automatic Electric Brush.

NOTE

Risk of damage from improper use!

- Avoid working with the device in one specific spot for a prolonged period of time.
- Avoid vacuuming up rugs/fringes.

Legend

- | | |
|---|---|
|  | Pivot |
|  | Carpet/hard floor operating display |
|  | Inspection flap |
|  | Ultrasound sensor |
|  | Rear sealing lip |
|  | Front sealing lip |
|  | Roller brush |
|  | Floor plate |
|  | Supporting roller |
|  | Switching between modes on hard floor (flex/fine) |
|  | Type plate |

3.1.1 OPERATING DISPLAY AND FLOOR MODE

There are four operating modes for cleaning floors with the Automatic Electric Brush. The selected operating mode is shown on the display:

LED display	Operating mode
1 Bar lit continuously	Automatic hard floor mode The Automatic Electric Brush has detected a hard floor using intelligent floor detection and automatically vacuums in hard floor mode.
2 Fringes lit continuously	Automatic carpet mode The Automatic Electric Brush has detected carpet using intelligent floor type detection and automatically vacuums in carpet mode.
3 Bar flashes slowly	Manual hard floor mode You have manually switched to hard floor mode using the function key on the handle of the Upright Vacuum Cleaner.
4 Fringes flash slowly	Manual carpet mode You have manually switched to carpet mode using the function key on the handle of the Upright Vacuum Cleaner.
5 LED display not lit.	Brush mode deactivated The Automatic Electric Brush is deactivated by holding down the function key 1 on the handle of the Upright Vacuum Cleaner for approx. 5 seconds. This is recommended for deep pile or very thick carpets. Hold down the function key 1 again for approx. 5 seconds to reactivate brush mode.

3.1.2 INTELLIGENT FLOOR TYPE DETECTION

The Automatic Electric Brush is equipped with intelligent floor detection. The electronic brush detects the floor type to be cleaned via a sensor and automatically adjusts the suction process for the different floor types: hard floors or carpet.

The Automatic Electric Brush starts with intelligent floor detection as soon as you switch on the vacuum cleaner using the main switch.

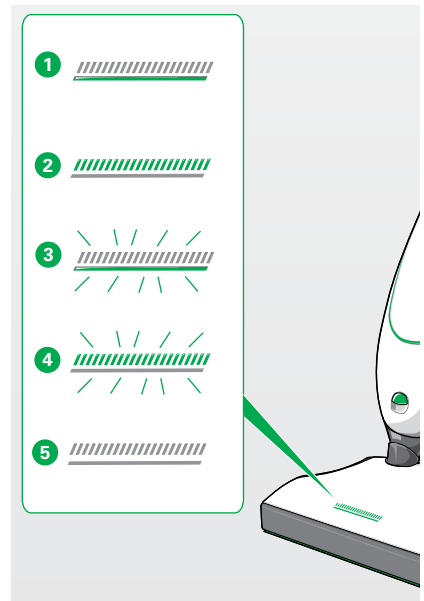

3.1.3 MANUALLY SWITCHING BETWEEN HARD FLOOR/CARPET MODE

You can also set the floor mode manually using the function key **1** on the handle of the Upright Vacuum Cleaner.

1. Select the correct power performance level for your floor according to the table on page 38.
2. Press the function key **1** on the main switch of the Upright Vacuum Cleaner to switch between hard floor mode and carpet mode.

The operating display (figure on page 35) flashes when the mode is manually set.

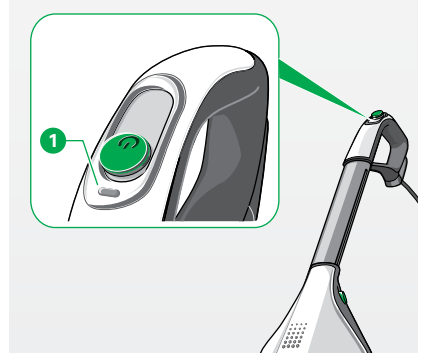

3.1.4 REACTIVATING INTELLIGENT FLOOR DETECTION

When you manually change the operating mode, intelligent floor detection is deactivated.

1. You can reactivate the automatic function by switching the Upright Vacuum Cleaner off and back on again.

3.1.5 FLOOR CLEANING

CAUTION

Risk of injury from debris flying out!

- Avoid abruptly placing the device on loose, coarse debris (e.g. glass shards), especially at eye level.
- Switch off the Kobold VK200 Upright Vacuum Cleaner before lifting up the EB400 Automatic Electric Brush.

NOTE

Risk of damage from improper use!

- Avoid working with the device in one specific spot for a prolonged period of time.
- Avoid vacuuming up rugs/fringes.

SWITCHING BETWEEN FLEX/FINE

Flex setting	Your Automatic Electric Brush is perfectly pre-set with the flex setting for everyday vacuuming.
Fine setting	You can adjust the Automatic Electric Brush specifically for vacuuming fine dust from joints and cracks. You will obtain maximum dust collection, from a wooden floor with lots of joints for example.

CAUTION

Risk of injury due to the rotating brush!

- Always switch the Kobold VK200 Upright Vacuum Cleaner off at the main switch before changing the setting on the bottom of the Kobold EB400 Automatic Electric Brush.

1. Switch the Upright Vacuum Cleaner off at the main switch.
The Automatic Electric Brush automatically defaults back to carpet mode.
2. Move the slider **1** on the underside of the device to position **2** (fine) for fine dust from joints or position **3** (flex) for picking up coarse material from smooth floors.

 We generally recommend the flex setting. Only select the fine setting for floors with large joints or cracks, such as wooden floorboards.

 When the Kobold EB400 Automatic Electric Brush is in hard floor mode, the slider cannot be operated. In this case, switch the Kobold VK200 Upright Vacuum Cleaner off and back on again at the main switch to set the Kobold EB400 Automatic Electric Brush to carpet mode.

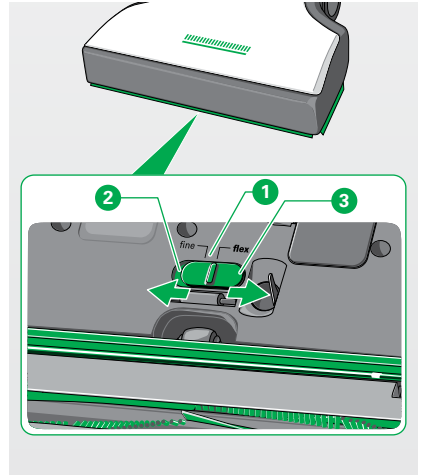

TIPS FOR BRUSH-SUCTION

We generally recommend using the power performance level auto. On this power setting, the fully automatic propulsive force control makes it possible to achieve a smooth sliding motion that is adjusted to the floor type. The other power performance levels are specially intended for specific types of carpet:

Power performance level	With normal function for the floor types
soft (50 W)	<ul style="list-style-type: none">– light rugs, floor mats– silk carpeting– carpets with fringes– delicate deep-pile carpeting– deep-pile carpeting– very thick velour carpeting
auto or med, max	<ul style="list-style-type: none">– hard floors– stairs– Sisal floors

1. Use the max power performance level for carpeted floors with excessive amounts of fine dust.
2. Floor detection should always be activated when using the Automatic Electric Brush.
3. Set the correct power performance level according to the table.
4. If you want to brush-suction a delicate floor even more gently, activate hard floor mode using the function key before moving onto the surface.
5. Every time you switch on the Upright Vacuum Cleaner, you will need to switch back to hard floor mode if you want to continue using this, as the hard floor mode is automatically deactivated when the Upright Vacuum Cleaner is switched off.
6. Move the device evenly back and forth.

i For vacuuming under furniture with little ground clearance, set the Automatic Electric Brush to the power setting and lay the Upright Vacuum Cleaner flat on the floor.

i If you put the Kobold VK200 Upright Vacuum Cleaner in the standby position temporarily, the rotating brush shuts off automatically.

3.1.6 FOR CARPET OR TEXTILE FLOORING

1. Never let the device work in one place for a longer period, otherwise the carpet may be damaged.
2. Keep moving the device back and forth during operation.
3. To make sure that the Automatic Electric Brush cleans the area in front and at the sides right up to the edges, vacuum with the side of the brush parallel to the edge.

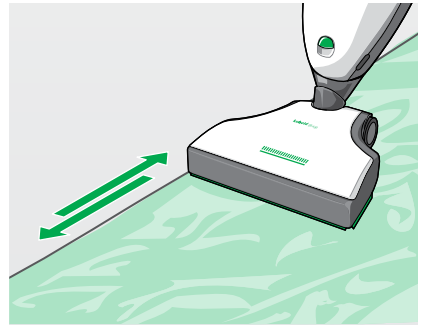

i The rotating roller brush can also work 'mechanically' and comb the fringes of a rug when used in hard floor mode. Only pull the Kobold EB400 Automatic Electric Brush over the fringes backwards, away from the carpet.

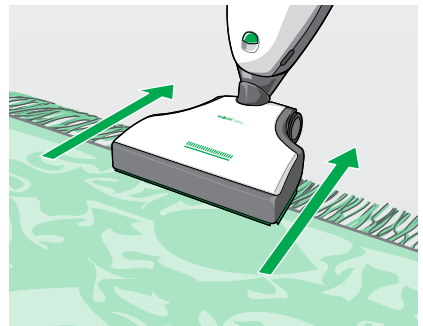

3.1.7 COMBINATION WITH OLDER VACUUM CLEANER MODELS

i If you use the Kobold EB400 Automatic Electric Brush in combination with the Kobold VK150 Upright Vacuum Cleaner or older models, the manual switch between modes and the suction regulation in the 'auto' setting are not available.

3.2 KOBOLD VF200 CARPET FRESHENER

Use the Kobold VF200 Carpet Freshener to professionally clean your carpet. This chapter tells you how.

1. Before you start using the Carpet Freshener, vacuum the carpet as usual with the Automatic Electric Brush (see chapter “3.1.1 Operating display and floor mode” on page 35).
2. Remove the Automatic Electric Brush from the Upright Vacuum Cleaner (see chapter “2.4 Removing and replacing the accessory head” on page 22).
3. Now attach the Carpet Freshener to the Upright Vacuum Cleaner (see chapter “2.4 Removing and replacing the accessory head” on page 22).

3.2.1 CARPET CLEANING WITH THE KOBOLD VF200 CARPET FRESHENER

WARNING

Risk of electric shock!







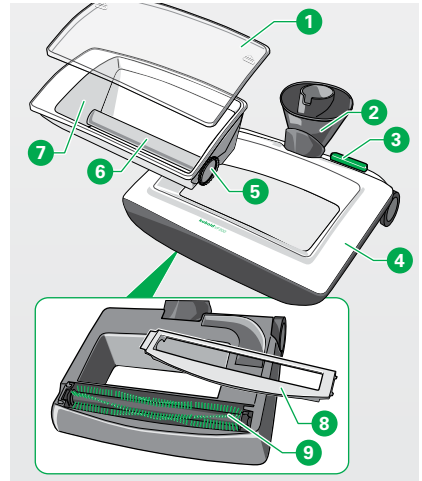

- Never drive your Kobold VF200 Carpet Freshener over the power cord or other cables on the floor.

 We recommend cleaning carpets every 1 - 4 months depending on the amount of use.

 If possible: Remove all moveable furniture before you begin cleaning.



Legend

- | | |
|---|--|
|  | Dosage hopper cover |
|  | Pivot |
|  | Foot switch (activate/deactivate Kobosan dosage) |
|  | Kobold VF200 Carpet Freshener |
|  | Side dosage wheel |
|  | Dosage roller |
|  | Dosage hopper |
|  | Brush cover |
|  | Roller brush |

i We recommend Kobosan Active for cleaning carpets and rugs. It contains what is known as the anti-soil formula. Thanks to this formula, your carpets will not absorb dry dirt as quickly and will stay clean for longer. Kobosan Active has been certified as suitable for allergy sufferers by TÜV NORD.

i One bag of Kobosan Active is enough for 3.5-7 m² of carpet, depending on the degree of soiling.



Kobosan Active can be purchased from the Mail Order Hotline (see chapter “8 Services” on page 116).



Kobosan Active can also be obtained from our online shop at www.vorwerk.co.uk

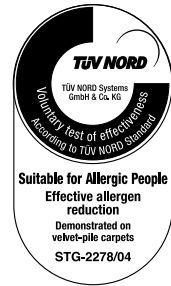

WARNING

Risk of electric shock!

- Never use the Kobold VF200 Carpet Freshener in combination with liquid, foam or wet cleaning agents.
- Only use dry cleaning powders such as Kobosan Active.
- Always switch the device off and disconnect the mains plug before all retrofitting, cleaning and maintenance work.
- Never pull the mains plug from the socket by the power cord, only by the plug.

NOTE

Risk of damage from improper use!

- Prior to application, Kobosan Active should be tested for colour fastness on an inconspicuous area of carpet.
- Do not use the Kobold VF200 Carpet Freshener on rug fringes as they could get damaged.
- Do not use the Carpet Freshener on the following floors:
 - Carpets with a pile height greater than 1.5 cm
 - Needle felt and similar flooring
 - Coco or sisal flooring
- Please note that a larger amount of wool abrasion can occur with loosely woven wool carpets or Berber-style pile carpeting.

3.2.2 FILLING THE DOSAGE HOPPER

The removable dosage hopper is installed inside the Carpet Freshener.

1. Insert the dosage hopper **2** into the Carpet Freshener **4**. Make sure that distribution is deactivated first (switch **3** is up).
2. Open the cover **1** of the dosage hopper **2** by pushing it forward slightly and then lifting it out.
3. Add the desired amount of Kobosan Active maximum 500g evenly to the dosage hopper **2**.
4. Close the dosage hopper **2** (put the cover on and slide it closed).

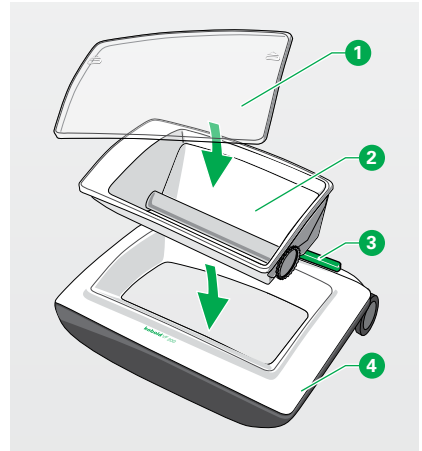

3.2.3 KOBOSAN ACTIVE DOSAGE

1. Operate Kobosan Active dosage with the foot switch **1**.
 - Switch up:
Kobosan Active distribution = deactivated **2**.
 - Switch down:
Kobosan Active distribution = activated **3**.
2. Switch the vacuum cleaner to the power performance level auto.
The suction motor starts and drives the brush of the Carpet Freshener. Kobosan Active is brushed directly into the carpet.
3. Move the Carpet Freshener back and forth in adjacent passes.
4. For a normal level of dirt you optimally cover the area of the carpet with Kobosan Active by travelling over it once.
5. After one pass over the area being cleaned, deactivate the dosage hopper by pressing the foot switch **1**.

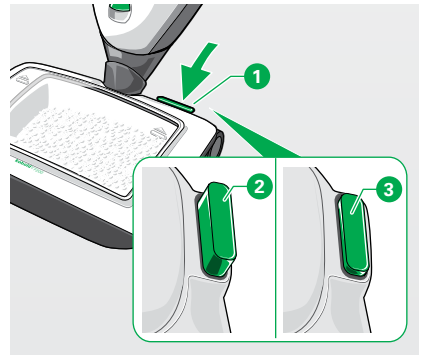

i The dosage hopper does not have to be deactivated if it is empty.

3.2.4 WORKING IN KOBOSAN ACTIVE

1. Make sure that the dosage hopper is deactivated .
2. Run the Carpet Freshener over the area covered with Kobosan Active at right angles to the direction you were previously working in.
3. Massage the Kobosan Active in to the carpet for up to three minutes per square metre, depending on the degree of dirt, in all four directions.
4. Then open the windows and allow it to dry. Depending on the type of carpet and the room temperature, drying should not take longer than 30 minutes.



Once Kobosan Active has been worked in, you no longer need the Carpet Freshener. The Carpet Freshener should be cleaned immediately after every use (see chapter “3.2.7 Cleaning the Kobold VF200 Carpet Freshener after use” on page 45).

3.2.5 REPLACING THE ACCESSORY HEAD

1. Make sure that the Upright Vacuum Cleaner is switched off and the mains plug is disconnected from the socket.
2. Remove the Carpet Freshener from the Upright Vacuum Cleaner (see chapter “2.4 Removing and replacing the accessory head” on page 22) and replace it with the Automatic Electric Brush.

3.2.6 VACUUMING UP KOBOSAN ACTIVE

1. Use the Automatic Electric Brush to vacuum the dried Kobosan Active from the carpet.



Any residue remaining in the carpet or rug does no harm. This residue will be vacuumed up over time with daily cleaning.

3.2.7 CLEANING THE KOBOLD VF200 CARPET FRESHENER AFTER USE



WARNING

Risk of electric shock!

- Be sure to take the Kobold VF200 Carpet Freshener off the Kobold VK200 Upright Vacuum Cleaner before cleaning.

NOTE

Risk of damage from improper use!

- Never use cleaning agents, solvents or alcohol to clean the Kobold VF200 Carpet Freshener.
- Before cleaning, take the Carpet Freshener off the Kobold VK200 Upright Vacuum Cleaner.
- Never clean the entire device under running water since water may remain in the device.
- Do not dry the Carpet Freshener near a radiator or in direct sunlight since the plastic may warp.



The Carpet Freshener should be cleaned immediately after every use.

CLEANING THE DOSAGE HOPPER

1. Remove any residue of Kobosan Active from the dosage hopper by using, for example, the Flexo Nozzle or Electric Suction Hose.
2. If it is very dirty, clean the dosage hopper under cold or lukewarm running water.
3. In order to do so, take the dosage hopper **3** out of the Carpet Freshener **1**.
4. Remove the cover **2**.

i The dosage hopper can only be removed after dosage has been deactivated (see chapter "3.2.3 Kobosan Active dosage" on page 43).

5. Remove the dosage roller **3** from the hopper. However, this is only necessary if it is very dirty (see chapter "4 Maintenance" on page 85).
6. Dry the dosage hopper and cover.

CLEANING THE BRUSH

1. Open the brush cover **2** on the underside of the device by pressing from the side **1**.
2. Take out the brush **3** and hold it on the side with the pin **4**.
3. Rinse out the brush under cold or lukewarm running water straight after every use. Make sure that the pin does not come into contact with water.
4. Shake excess water off the brush.
5. Once it has dried, reinstall the brush in the Carpet Freshener (set onto the pin and swing in) and close the brush cover on the device.

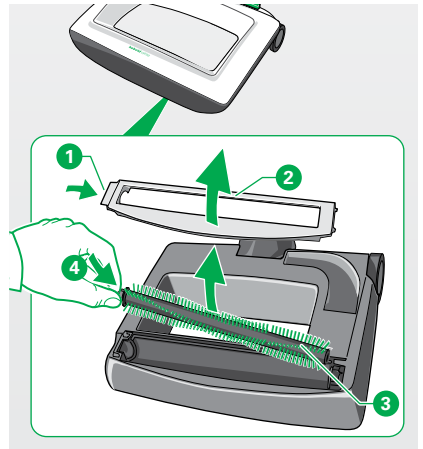
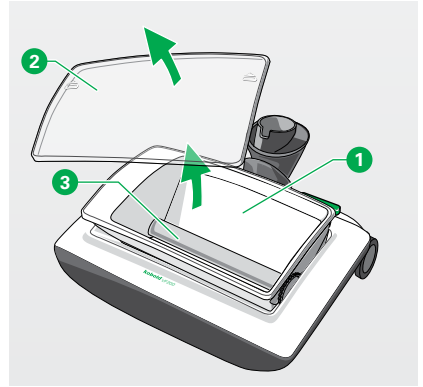

3.2.8 REMOVING OLD STAINS

NOTE

Risk of damage from improper use!

- Prior to application, Kobotex should be tested for colour fastness on an inconspicuous area of carpet.

Old stains may become visible or be more apparent than before on the carpet after cleaning. They can almost always be removed with Kobotex.

1. Remove the stains with Kobotex **1** according to the instructions on the bottle.



3.3 KOBOLD SP600

The Kobold SP600 makes it possible to vacuum and wet-clean hard floors in a single step – saving a considerable amount of time and effort.

The Kobold SP600 is particularly efficient for cleaning hard floors. It is also possible to buff/clean your floors with a dry cloth using the SP600.

For particularly thorough cleaning, the SP600 has its own motor which drives the cloth holder and cleaning cloth.

The SP600 can be used on almost all types of hard floors.

1. Nevertheless, before using it, make sure that the device is suitable for your floor (see table “Suitability of the accessory heads for floors” on page 8).

WARNING

Risk of electric shock!

- Never drive your Kobold SP600 over the power cord or other cables on the floor.
- Do not vacuum liquids.





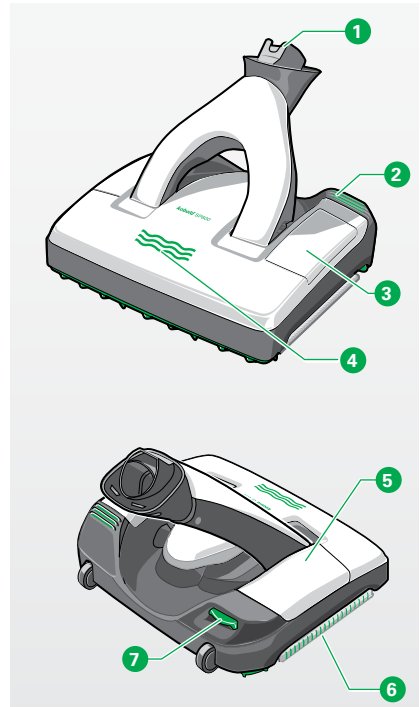

CAUTION

Risk of injury from rotating parts!

- Keep away from the rotating parts on the Kobold SP600.



Legend

- | | |
|---|--|
|  | Pivot |
|  | Pedal for releasing the cloth holder |
|  | Inspection flap |
|  | LED wave symbol |
|  | Tank installed |
|  | Cleaning cloth on cloth holder in the device |
|  | Tank release mechanism |

3.4 ACCESSORIES FOR THE KOBOLD SP600

3.4.1 KOBOCLEAN

The concentrated cleaning agent Koboclean is suitable for cleaning various types of sealed hard floors. Thanks to its high cleaning power, even stubborn dirt can be removed reliably. Koboclean satisfies all requirements regarding environmental compatibility and biodegradability. The following types are available:



Koboclean Universal

For use on all surfaces that can be wiped with a damp cloth (e.g. tiles, PVC).

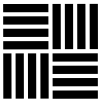

Koboclean Parquet

Specially developed for cleaning wooden surfaces (e.g. cork, parquet, laminate).

The concentrated cleaning agent Koboclean must be diluted before being used. It must not be applied undiluted.

NOTE

Risk of damage from improper use!

- Only use original Kobold cleaning cloths.

3.4.2 KOBOLD MF600 CLEANING CLOTHS

The cleaning cloths have been specially developed for the SP600.

The cleaning cloth is available in the following four types:

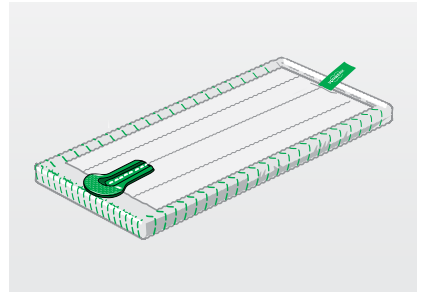

Kobold MF600 Universal

Is particularly suitable for all surfaces that can be wet-cleaned (e.g. tiles, PVC, also suitable for textured surfaces).



Kobold MF600 Universal Soft

Is particularly suitable for use on porous or shiny floors (e.g. marble, granite, artificial stone, laminate).

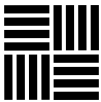

Kobold MF600 Parquet

Is particularly suitable for wet-cleaning wooden floors (e.g. parquet, sealed cork flooring).



Kobold MF600 Dry

Is particularly suitable for dry-cleaning hard floors.



The Universal Soft, Parquet and Dry cleaning cloths are not included in the delivery of the basic set.



For optimum cleaning performance, we recommend washing the MF600 cleaning cloths at 60 °C without fabric softener before first use.



Please refer to the overview table on the following page.

3.4.3 SUITABILITY OF THE KOBOLD MF600 CLEANING CLOTHS FOR DIVERSE HARD FLOOR TYPES

Hard floor type	Universal	Universal Soft	Parquet	Dry
Sealed/varnished wooden floors (floorboards, parquet)	+ ¹	+ ¹	++	++ ¹
Oiled/waxed wooden floors	+ ¹	+ ¹	++	++ ¹
Unsealed/untreated wooden floors	–	–	–	+ ¹
Sealed cork floors	+ ¹	+ ¹	++	++ ¹
Oiled/waxed cork floors	–	–	–	+ ¹
Unsealed/untreated cork floors	–	–	–	+ ¹
Laminate	+	++	+	++
Elastic floors (PVC, cushion vinyl, linoleum)	++	++	–	++
Stone floors (marble, granite, Jura limestone, artificial stone)	++	++ ²	–	++
Porous/delicate natural stone (slate, clinker tiles)	+	+ ²	–	++
Clay floors (terracotta, clinker, brick clay tiles)	++ ²	++ ²	–	++
Ceramic glazed tiles and fine stoneware	++	++ ²	–	++
Untreated tiled floors	–	–	–	+
Rough concrete flooring (washed concrete)			excluded	
Textile flooring			excluded	

The symbols mean:

- ++ excellent suitability
- + good suitability
- not suitable

¹) Cloths contain microfibres; follow the cleaning and care information issued by the manufacturer.

²) Increased wear is possible on rough floors.

3.4.4 ATTACHING THE KOBOLD SP600

The SP600 must first be attached to the Kobold vacuum cleaner:

1. Connect the attachment socket **1** of the vacuum cleaner to the pivot on the SP600 **2**.
2. Make sure you hear the attachment socket click into the pivot.

3.4.5 SETTING AND RELEASING THE STANDBY POSITION ON THE KOBOLD SP600

The Kobold vacuum cleaner can be combined with the Kobold SP600 in the usual way and either used in the power setting or put into the standby position.

PUTTING THE DEVICE INTO THE STANDBY POSITION

CAUTION

Risk of falling and causing injury!

The standby position is used to park the device after you have finished working with it or when you take a break.

- Ensure that the Kobold VK200 Upright Vacuum Cleaner and Kobold SP600 are placed on a level surface when put in the standby position.
- Never use the Kobold VK200 Upright Vacuum Cleaner to support yourself.
- Never stand on the accessory heads.

NOTE

Risk of damage when the device starts up automatically.

- Note that the vacuum cleaner and the Kobold SP600 start up automatically when the vacuum cleaner is taken out of the standby position if you have not first switched off the vacuum cleaner at the main switch.

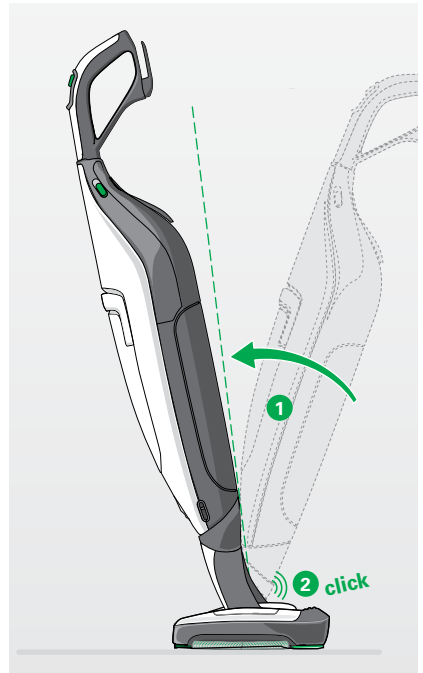
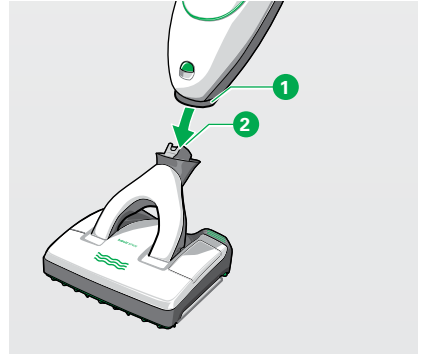

1. Turn the vacuum cleaner at the pivot so that both the vacuum cleaner and the SP600 are centred.
2. Push the vacuum cleaner forwards **1** over the SP600.
*The vacuum cleaner clicks into the standby position **2**.*

TAKING THE DEVICE OUT OF THE STANDBY POSITION

To take the vacuum cleaner and SP600 out of the standby position:

1. Push the vacuum cleaner a little further forwards **1** until you hear a click **2**.
The vacuum cleaner is now no longer in the standby position.
2. Put the vacuum cleaner in the power setting in the usual way **3**.

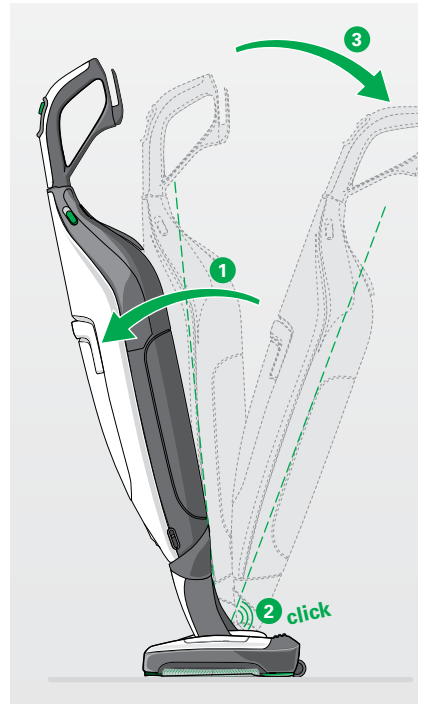

3.4.6 GETTING THE KOBOLD SP600 READY FOR USE

RELEASING THE CLOTH HOLDER FROM THE KOBOLD SP600

WARNING

Risk of electric shock!

- For your own safety, switch off the vacuum cleaner at the handle every time you replace the MF600 cleaning cloth.

To attach the cleaning cloth to the cloth holder, the cloth holder must first be removed.

1. Attach the SP600 to the vacuum cleaner as described in the chapter “3.4.4 Attaching the Kobold SP600” on page 52.
2. Put the vacuum cleaner in the standby position as described in the chapter “3.4.5 Setting and releasing the standby position on the Kobold SP600” on page 52.
3. Tilt the vacuum cleaner backwards in the standby position **1**.
The SP600 is now positioned on its rollers.
4. Press the green pedal positioned at the back of the vacuum cleaner on the left with your foot **2**.
*The cloth holder is released from the device **3**.*

 It is only possible to eject the cloth holder when the Kobold vacuum cleaner is tilted backwards on its rollers in the standby position.

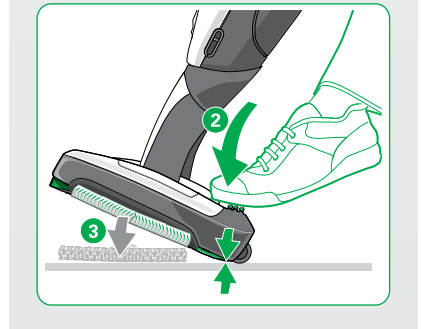

ATTACHING THE KOBOLD MF600 CLEANING CLOTH TO THE CLOTH HOLDER

NOTE

Risk of damage from improper use!

- When attaching the cleaning cloth to the cloth holder, always ensure that the cloth is fastened evenly. The cloth must not be positioned at an angle to the cloth holder.

1. To attach the cleaning cloth to the cloth holder, push the green nose **1** of the cleaning cloth into the slot on the cloth holder as far as it will go.
2. Then press the cloth holder directly onto the cloth **2**.

*The back of the cloth is fastened to the cloth holder using Velcro and the cloth fits into place **3**.*

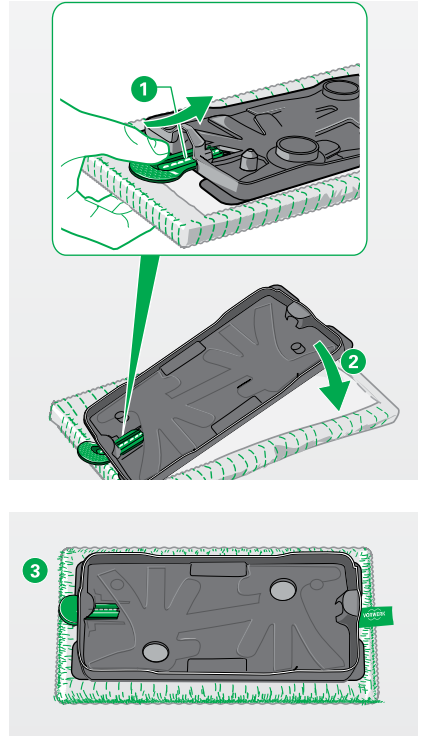

ATTACHING THE CLOTH HOLDER TO THE SP600

WARNING

Risk of electric shock!

- For your own safety, switch off the vacuum cleaner at the handle every time you replace the MF600 cleaning cloth.

NOTE

Risk of damage from improper use!

- Avoid forced insertion and extraction of the cloth holder.

1. Place the cloth holder onto the floor with the cloth correctly attached.
2. Tilt the vacuum cleaner backwards in the stand-by position **1**.
The SP600 is now positioned on its rollers.
3. Roll the vacuum cleaner directly onto the cloth holder.
4. Tip the vacuum cleaner onto the cloth holder **2**.
*The cloth holder will click as it engages with the SP600 **3**. The device is now ready for use.*

 The cloth holder is symmetrical. You simply need to approach the cloth holder square on to ensure that the SP600 correctly engages with the cloth holder.

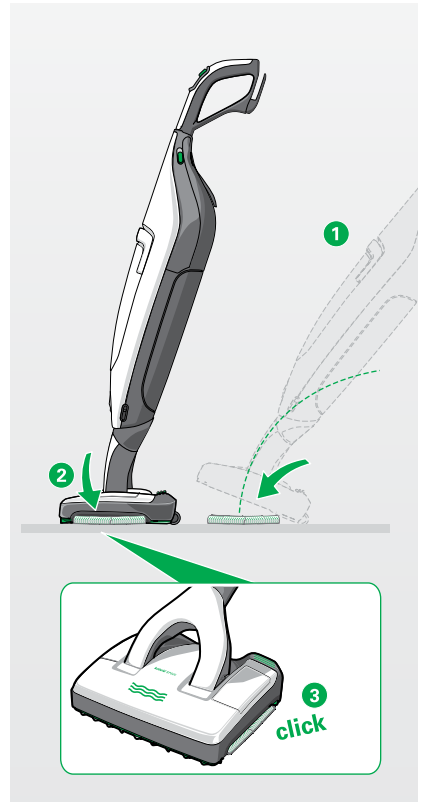

REMOVING, FILLING AND INSERTING THE TANK

WARNING

Risk of electric shock!

- Always switch the device off and disconnect the mains plug before all retrofitting, cleaning and maintenance work.

NOTE

Risk of damage from improper use!

- Avoid forced insertion and extraction of the tank.

For wet cleaning, moisture is applied to the cloth from the tank in the SP600.

1. Remove the tank from the SP600. To do this, gently pull up the green tank release mechanism at the back of the SP600 **1** and pull the tank backwards to lift it out.
2. Unscrew the tank cap **2**.
3. Fill the tank cap with Koboclean as far as the line (3ml) **3**.
4. Pour this quantity into the tank **4**.
5. Fill the tank with fresh tap water to the maximum mark **5**.
6. Put the cap back onto the tank and do it up.
7. Insert the tank into the SP600. This is done by first pushing the front of the tank into the SP600 **6** and then pressing the back of the tank into its holder **7**.

You will hear the tank snap into place.

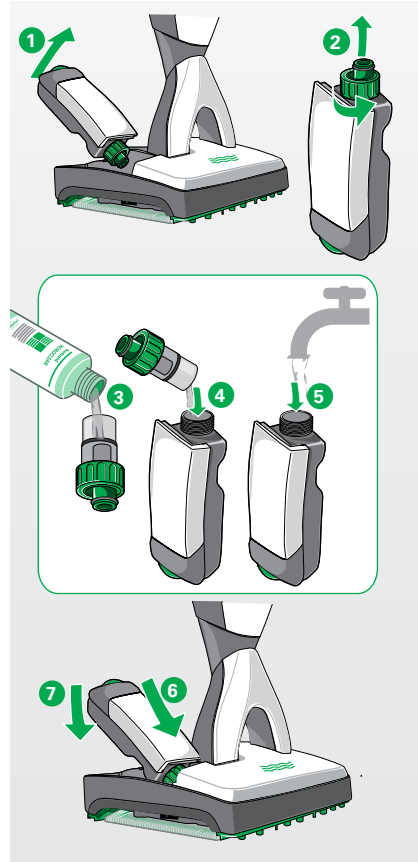

3.4.7 SWITCHING THE SP600 ON AND OFF

WARNING

Risk of electric shock!

- Never drive your Kobold SP600 over the power cord or other cables on the floor.
- Do not vacuum liquids, damp dirt or damp floor mats or carpets.
- Do not use the device in damp environments.
- Do not use the electrical accessories on wet surfaces or outdoors under any circumstances.

CAUTION

Risk of injury from rotating parts!

- Keep away from the rotating parts on the Kobold SP600.

NOTE

Risk of damage from improper use!

- Before switching on the device, make sure that there are no small stones, granulates such as cat litter or other pointed or sharp-edged objects under the cleaning cloth.
- Never work on the same spot for more than 10 seconds.
- Never leave the device standing on the floor with a wet cloth for a long period of time (more than 30 seconds). Otherwise, delicate floors may be damaged.
- Never leave the Kobold SP600 with a wet cloth on floors that are extremely sensitive to moisture (e.g. untreated cork or wooden flooring).
- Never use the Kobold SP600 without the cleaning cloth.

SWITCHING ON

To switch the SP600 on, you need to switch the vacuum cleaner on:

1. Take the vacuum cleaner out of the standby position as described in the chapter “Taking the device out of the standby position” on page 53.

The vacuum cleaner is now no longer in the standby position.

2. Switch the vacuum cleaner to the power performance level auto.

The vacuum cleaner starts running, the LED lights up as usual and the SP600 starts operating in dry mode (further information on this can be found in the chapter on “3.4.8 Automatic application of moisture and dry mode” on page 61).

SWITCHING OFF THE DEVICE

To switch off the Kobold SP600, you need to switch off the vacuum cleaner:

1. Switch the vacuum cleaner off at the handle and put it into the standby position.

STOPPING BRIEFLY

If you want to stop the SP600 for a short period of time only (less than 30 seconds), it is possible to put the vacuum cleaner in the standby position.

1. Put the vacuum cleaner into the standby position.

The SP600 will switch off automatically. The LED on the Kobold vacuum cleaner stays on.

2. Put the vacuum cleaner back into the power setting.

The SP600 switches on again automatically and runs in dry mode (further information on this can be found in the chapter “3.4.8 Automatic application of moisture and dry mode” on page 61).

3.4.8 AUTOMATIC APPLICATION OF MOISTURE AND DRY MODE

The SP600 can moisten the cleaning cloth on three different settings. In addition, you can activate a one-off full saturation of the cloth by pressing a button, e.g. when you are just about to start cleaning.

NOTE

Material damage can occur when used on unsuitable floors!

- For delicate floors, such as floors which are not permanently sealed (oiled cork, oiled parquet, coated, oiled stoneware), we recommend that you first test the device in an inconspicuous area to prevent damage to the floor.
- Please also refer to the cleaning and care information issued by the floor manufacturer.

NOTE

Risk of damage from prolonged contact with water!

- In the case of floors that are extremely sensitive to moisture, wipe dry with a dry Kobold MF600 Parquet cleaning cloth and set the vacuum cleaner to full power.
- If the floor is too wet, wipe with a dry MF600 Parquet or Dry cleaning cloth in dry mode.



Never dampen the cleaning cloth by hand. Moisture may only be applied to the cleaning cloth by the SP600.



Wash the cleaning cloth according to the washing instructions before first use (see chapter "Cleaning the Kobold MF600 cleaning cloths" on page 69).

LED WAVE SYMBOLS AT A GLANCE

LED wave symbol	Meaning
Dry mode	
1 No waves are lit.*	The SP600 is ready to use and is running in dry mode, without applying any moisture to the cloth. * (The Kobold vacuum cleaner is switched on and the SP600 is running).
Moisture setting 1	
2 One wave lit.	The SP600 is ready for use, the function key has been pressed once, the SP600 applies moisture to the cleaning cloth on the lowest setting.
Moisture setting 2	
3 Two waves lit.	The SP600 is ready for use, the function key has been pressed twice, the SP600 applies moisture to the cleaning cloth on the medium setting.
Moisture setting 3	
4 Three waves lit.	The SP600 is ready for use, the function key has been pressed three times, the SP600 applies moisture to the cleaning cloth on the highest setting.
Single application of moisture to a dry cloth	
5 All three waves flashing.	The SP600 is ready for use, the function key has been pressed down and held, the SP600 makes the cleaning cloth completely wet in a single application.
All waves lit up yellow.	The reservoir is empty.
All waves flashing red.	The inspection flap comes open, the SP600 has absorbed moisture (see chapter "5 Troubleshooting" on page 100).
All waves lit up red.	The SP600 has detected a fault (see chapter "5 Troubleshooting" on page 100).

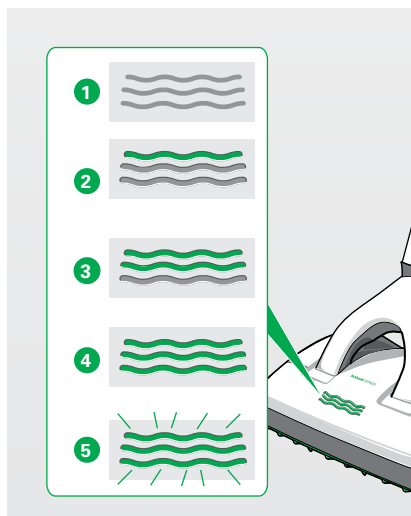

DRY MODE

After you have switched on the Kobold vacuum cleaner, the SP600 initially runs in dry mode. No LED waves are lit. 



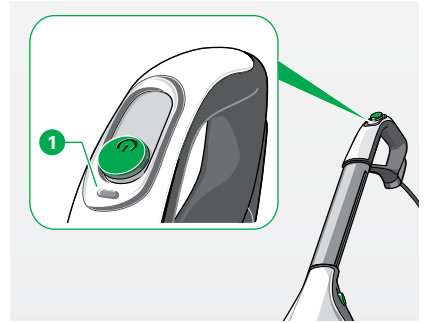

SINGLE APPLICATION OF MOISTURE TO A DRY CLOTH

1. Press the function key **1** on the handle of your vacuum cleaner for about five seconds to start the process of fully moistening the cloth. *The LED waves on the SP600 flash.* 

i After pressing the function key **1** the device automatically switches to setting 1.



CHANGING MOISTURE SETTINGS

1. Press the function key **1** on the handle of your vacuum cleaner to start the automatic application of moisture to the cloth. *The first of three LED waves light up on the SP600.* 
2. Press the function key again **1** to switch from the lowest setting to moisture setting 2. *Two out of three LED waves on the SP600 light up.* 
3. Press the function key a further time **1** to switch from moisture setting 2 to moisture setting 3. *All three LED waves on the SP600 light up.* 
4. Pressing the function key again **1** will return the SP600 to dry mode. *No LED waves are lit.* 

i If the cleaning cloth is too dry, increase the moisture setting by pressing the function key **1** on your Kobold vacuum cleaner.

RECOMMENDATIONS FOR MOISTURE SETTINGS

Hard floor type	Dry mode	Setting 1	Setting 2	Setting 3
Sealed/varnished wooden floors (floorboards, parquet)	++	++	+	+
Oiled/waxed wooden floors	++	+	-	-
Unsealed/untreated wooden floors	++	-	-	-
Sealed cork floors	++	++	+	+
Oiled/waxed cork floors	+	-	-	-
Unsealed/untreated cork floors	+	-	-	-
Laminate	++	++	+	+
Elastic floors (PVC, cushion vinyl, linoleum)	++	++	++	++
Stone floors (marble, granite, Jura limestone, artificial stone)	++	++	++	++
Porous/delicate natural stone (slate, clinker tiles)	++	++	++	++
Clay floors (e.g. terracotta, clinker, brick clay tiles)	++	++	++	++
Ceramic glazed tiles and fine stoneware	++	++	++	++
Untreated tiled floors	+	-	-	-
Rough concrete flooring (washed concrete)		excluded		
Textile flooring		excluded		

The symbols mean:

- ++ excellent suitability
- + good suitability
- not suitable

i The optimum moisture setting is also dependent on the speed with which you work. The quicker you work, the higher the moisture setting you can select.

i If the floor becomes too wet while working with the SP600, you can switch to a lower setting. (Further tips can be found in the tables (see chapter "5 Troubleshooting" on page 100).

WET CLEANING USING OLDER VACUUM CLEANER MODELS

You cannot control the automatic moisture function on your vacuum cleaner if you use the SP600 in combination with older models of Kobold vacuum cleaners such as the Kobold VK135/VK136/VK140/VK150 Upright Vacuum Cleaners. The moisture settings are not available.

To wet clean your floor using the SP600 in combination with an older model of Kobold vacuum cleaner, proceed as follows:

1. Operate the SP600 with the tank full.

Moisture is applied at predefined intervals.

You cannot influence this. One LED wave on the SP600 lights up. 

DRY MODE USING OLDER VACUUM CLEANER MODELS

To operate the SP600 in dry mode in combination with an older model of Kobold vacuum cleaner, proceed as follows:

1. Operate the SP600 with the tank empty or without inserting the tank.

3.4.9 WORKING WITH THE KOBOLD SP600

NOTE

Risk of damage from improper use!

- Never use the Kobold SP600 without the cleaning cloth.
- Never work on the same spot for more than 10 seconds.
- When working with the Kobold SP600, never use acid cleaning agents (e.g. vinegar-based cleaner) or highly alkaline cleaning agents (e.g. chlorine bleaching).
- Do not pour any polymer-containing cleaners or care products into the tank.

NOTE

- Please also refer to the care instructions issued by the floor manufacturer.

CAUTION

Risk of injury from debris flying out!

- Avoid moving the Kobold SP600 laterally towards loose coarse particles (e.g. glass splinters).
- Do not clean with the Kobold SP600 at eye level (e.g. on stairs and landings).
- Switch off the vacuum cleaner before lifting the Kobold SP600.

NOTE

Risk of damage from improper use!

- If the device hooks into objects or gets jammed, the Kobold VK200 Upright Vacuum Cleaner should be switched off immediately in order to prevent damage.

Due to the special cleaning performance of the SP600, it is possible that, when using the device for the first time, floors will have to be cleaned several times in order to remove engrained dirt. Afterwards, the SP600 will deliver a convincing cleaning performance after each application.

In combination with the SP600, we recommend always operating the vacuum cleaner with the power set to performance level auto.

1. Move the SP600 in regular paths.
2. Keep the SP600 constantly moving.

REMOVING AND REPLACING THE KOBOLD MF600 CLEANING CLOTH

NOTE

Risk of damage from improper use!

- Never leave a wet cleaning cloth in the Kobold SP600 when storing it.

1. Take the cloth holder.
2. With the other hand, take hold of the tab **1** on the cleaning cloth and fold it in half **2**.
3. Place your thumb on the green nose of the cleaning cloth **3** and pull it out of the cloth holder **4**.
4. Attach a clean cloth as described in the chapter “Attaching the Kobold MF600 cleaning cloth to the cloth holder” on page 55.

i The service life of a cleaning cloth depends on how dirty the floor is and on the floor type.

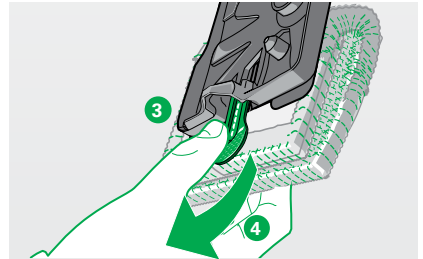
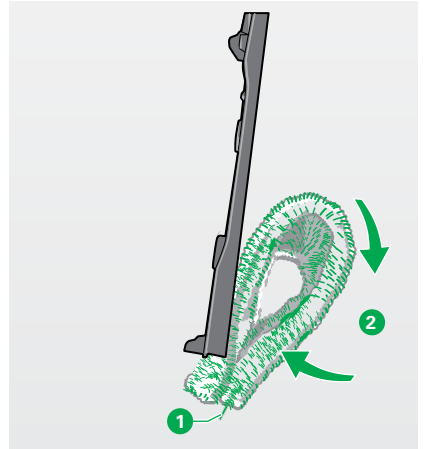

3.4.10 AFTER USING THE KOBOLD SP600

STORING THE KOBOLD SP600

NOTE

Risk of damage from improper use!

- When storing the device, never leave residual fluid in the tank. Empty the tank fully after each use.

1. Once you have finished cleaning, remove the tank from the SP600 as described in the chapter “Removing, filling and inserting the tank” on page 57.
2. Empty the tank.
3. Put the empty tank back in the SP600.
4. Remove the cloth holder from the SP600 and take off the cleaning cloth as described in the chapter “Releasing the cloth holder from the Kobold SP600” on page 54.
5. Store the SP600 with the tank inside and the cloth holder until you need them again.

CLEANING THE KOBOLD MF600 CLEANING CLOTHS

1. Wash dirty cleaning cloths in the washing machine at 60 °C without fabric softener. The cloths must never be washed with chlorine bleaching agents.
2. The cleaning cloths can be tumble-dried on a low setting.

3.5 KOBOLD PB440 ELECTRIC UPHOLSTERY BRUSH AND KOBOLD MP440/MR440 MATTRESS CLEANING SET

The Kobold PB440 Electric Upholstery Brush removes dust from your upholstered furniture in no time.

Furthermore, it cleans upholstery faster than any other device because it brushes and vacuums it at the same time. With the MP440/MR440 Mattress Cleaning Set attached to your Electric Upholstery Brush, you can professionally clean your mattresses as well. This chapter explains how to operate the Electric Upholstery Brush.

3.5.1 CLEANING UPHOLSTERY WITH THE KOBOLD PB440 ELECTRIC UPHOLSTERY BRUSH

CONNECTING THE KOBOLD PB440 ELECTRIC UPHOLSTERY BRUSH

CAUTION

Pinching hazard!

- Do not vacuum any body parts. Do not vacuum near children or pets.
- Do not vacuum your hair with the PB440 Electric Upholstery Brush.
- Do not operate the Kobold PB440 Electric Upholstery Brush without the suction nozzle or Mattress Cleaning Set.



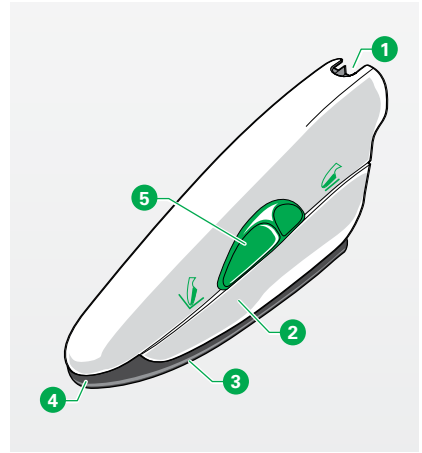

CAUTION

Risk of injury from debris flying out!

- Avoid abruptly placing the device on loose, coarse debris (e.g. glass shards), especially at eye level.



Legend

- | | |
|---|-------------------------------------|
|  | Attachment socket |
|  | Recessed grips |
|  | Suction nozzle |
|  | Suction nozzle opening for crevices |
|  | Slider |

1. Connect the Kobold ESS200 Electric Suction Hose **2** to the Upright Vacuum Cleaner **1** (see chapter “3.7 Kobold ESS200 Electric Suction Hose” on page 78).
2. Connect the Electric Upholstery Brush **3** to the Electric Suction Hose **2**.
3. To do this, slide the handle of the Electric Suction Hose into the attachment socket of the Electric Upholstery Brush.
4. Switch on the Upright Vacuum Cleaner.
The Electric Upholstery Brush is automatically switched on as well.

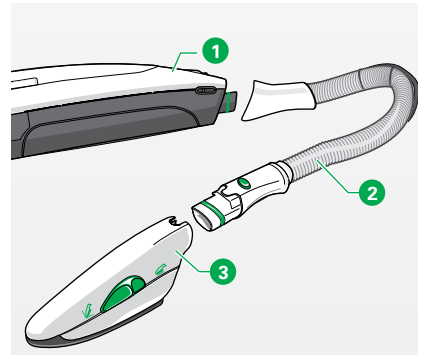

3.5.2 REGULATING THE SUCTION FORCE

1. Regulate the suction force as usual on the Upright Vacuum Cleaner.
2. Select power performance level med on your Upright Vacuum Cleaner in normal use.
3. Select power performance level soft on your Upright Vacuum Cleaner when dealing with loose and/or sensitive material.

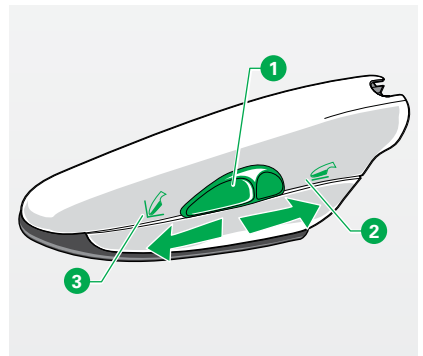

3.5.3 VACUUMING SURFACES

1. Move the green slide **1** into the position “vacuum surfaces” **2**.
2. During the cleaning process, place the suction openings of the Handheld Upholstery Brush completely on the upholstery.
3. Gently move the device over the upholstery without applying pressure.

3.5.4 VACUUMING CREVICES

1. Move the green slide into the position “vacuum crevices” **3**.
2. To vacuum particles in areas that are difficult to reach, such as crevices, grooves or similar areas, use maximum suction force – power level auto.

3.5.5 CLEANING MATTRESSES WITH THE KOBOLD PB440 ELECTRIC UPHOLSTERY BRUSH AND THE KOBOLD MP440/ MR440 MATTRESS CLEANING SET

To clean mattresses, use your Kobold PB440 Electric Upholstery Brush **1** with the Kobold MP440 Mattress Freshener **2** and the Kobold MR440 Mattress Vacuumer **3** instead of the normal suction nozzle. For regular vacuum cleaning of mattresses, the MR440 mattress cleaning set is recommended.

i We recommend Lavenia for cleaning mattresses. Lavenia not only easily removes dust, but also bacteria, mite faeces and mould spores to a large extent. Lavenia received the TÜV NORD certificate "suitable for allergy sufferers".

i Lavenia is not suitable for stain removal. Please use Kobotex for this purpose. Observe the leaflets included with Lavenia and Kobotex.



Lavenia can be purchased from the Mail Order department (see chapter "8 Services" on page 116).



Lavenia can also be obtained through an online shop at www.vorwerk.co.uk

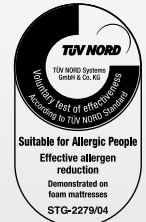
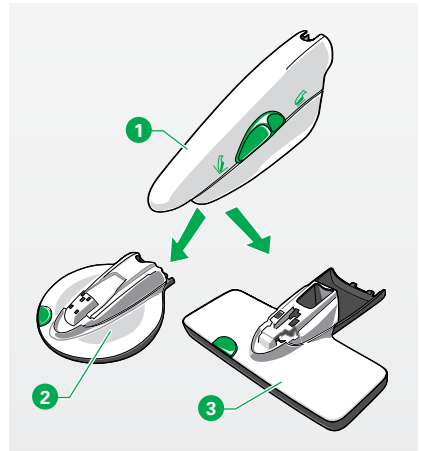

i Lavenia can be used with all mattresses with textile and solid surfaces.

i One bag of Lavenia will clean one double mattress.

NOTE

Risk of damage due to incompatibility of the cleaning agent!

- Test the colour fastness of the mattress against Lavenia in an inconspicuous spot before application.

NOTE

Risk of damage from improper use!

- Avoid working with the device in one specific spot for a prolonged period of time (max. 5 seconds).
- Do not vacuum mattresses with the suction nozzle of the Electric Upholstery Brush. Only use the Mattress Vacuumer MR440 to avoid damage to mattresses.
- Use Lavenia, the Mattress Freshener MP440 and the Mattress Vacuumer MR440 only on mattresses. The Mattress Cleaning Set is not suitable for use on other upholstery fabrics or furniture, and may damage sensitive materials.
- Use the Mattress Freshener MP440 with the corresponding nubbed disc exclusively for mattress cleaning.

3.5.6 REMOVING THE KOBOLD PB440 ELECTRIC UPHOLSTERY BRUSH SUCTION NOZZLE

1. Pull the suction nozzle **2** down and off the Electric Upholstery Brush by the gripping grooves **1**.

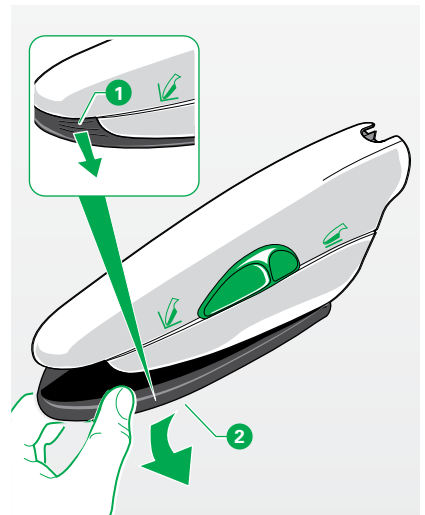

3.5.7 CLEANING MATTRESSES

1. Attach the Mattress Vacuumer **1** to the Electric Upholstery Brush.
2. Attach it with the latches **2** to the Electric Upholstery Brush **3** and lock the mattress vacuumer with one swivel motion **4** upwards towards the Electric Upholstery Brush.
3. Switch on the Upright Vacuum Cleaner with power performance level auto. The slide switch on the Electric Upholstery Brush must be switched to the setting for vacuuming surfaces.
4. Place the bottom of the Electric Upholstery Brush with Mattress Vacuumer flat onto the mattress.
The rubber beater bars start to vibrate audibly.
5. Vacuum the mattress with the Mattress Vacuumer.
6. Switch the Upright Vacuum Cleaner off.
7. Spread the contents of a bag of Lavenia cleaning agent (120g) evenly over the mattress.
8. Swap the Mattress Vacuumer for the Mattress Freshener. To do so push the green sliding button **5** outwards to release the lock. Attach the Mattress Freshener with the latches **6** and lock into the Electric Upholstery Brush with a swivel motion **4** upwards.
9. Switch the Electric Upholstery Brush to suction level auto.
The nubbed disc starts to rotate.

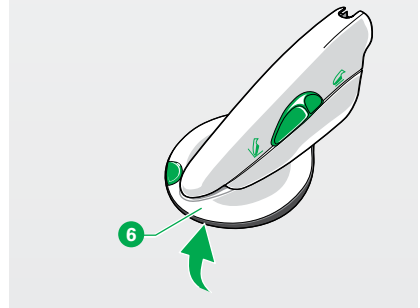
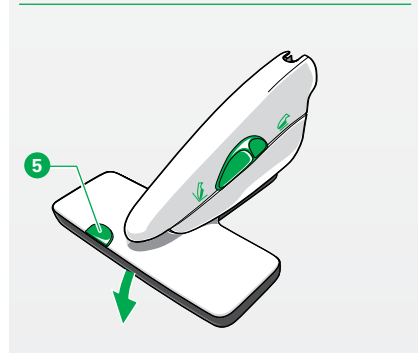
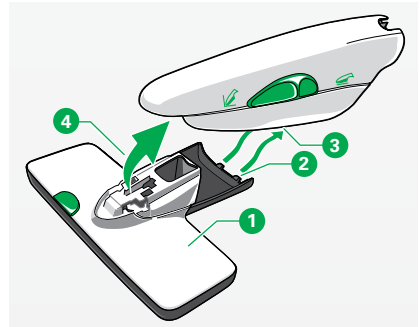



When using the Electric Upholstery Brush with the Mattress Freshener, the suction function of the Kobold VK200 Upright Vacuum Cleaner is switched off automatically. While you are working in the Lavenia, only the motor of the Kobold PB440 Electric Upholstery Brush runs to drive the nubbed disc of the Mattress Freshener MP440. When older Electric Upholstery Brush models are used, the Kobold VK200 Upright Vacuum Cleaner continues running. In this case we recommend the power performance level soft.

10. Lay the Mattress Freshener MP440 with the nubbed disc flat onto the mattress, without a lot of pressure, in order to evenly distribute Lavenia over the entire surface.

NOTE

Risk of damage from improper use!

- Do not press the Kobold PB440 Electric Upholstery Brush with the Mattress Freshener MP440 firmly onto the mattress with both hands. Doing so could cause damage to your Mattress Cleaning Set and mattress.

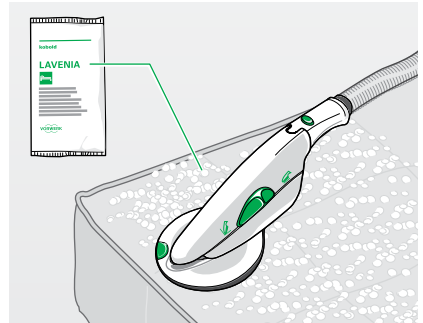

11. Work in the Lavenia with the Mattress Freshener for 2-3 minutes on an area of about 1 x 2 metres.
12. Allow the powder to dry for about 30 minutes. Ensure good ventilation.
13. Then exchange the Mattress Freshener for the Mattress Vacuumer. Proceed as described above for changing accessory heads.
14. Switch on the Upright Vacuum Cleaner with power performance level auto. The sliding switch on the Electric Upholstery Brush has to be in the surface cleaning position **1**.
15. Place the bottom of the Electric Upholstery Brush with Mattress Vacuumer flat onto the mattress.
The rubber beater bars start to vibrate audibly.
16. Vacuum up the Lavenia with the Electric Upholstery Brush and Mattress Vacuumer.

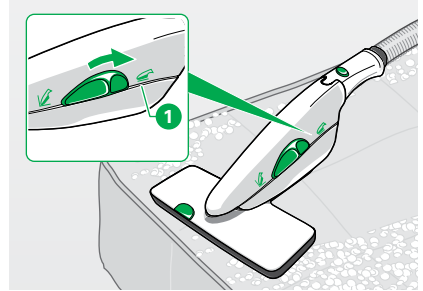

3.5.8 CLEANING THE MATTRESS FRESHENER MP440 AND MATTRESS VACUUMER MR440 AFTER USE

1. After each use, check the Mattress Cleaning Set for dirt residue.
2. Vacuum away any Lavenia residue or wet clean the device if it is very dirty.
For instructions, see the chapter “4.5 Kobold PB440 Electric Upholstery Brush and Kobold MP440/ MR440 Mattress Cleaning Set” on page 97.

3.6 KOBOLD HD60 HARD FLOOR NOZZLE

The Kobold HD60 Hard Floor Nozzle has been specially designed to make all types of shiny hard floors easier to clean. In contrast to other hard floor nozzles that are currently available, it is suitable for removing coarse dirt. It can easily be manoeuvred around pieces of furniture and furniture legs, and vacuums flush with the skirting board.

The Hard Floor Nozzle is a special nozzle that can be used on most floors.

1. To find out which floors it is suitable for, please refer to the table on page 8.



CAUTION

Choking hazard due to swallowing small parts!

- Keep small parts, such as the inspection flap cover, out of the reach of children.



CAUTION

Risk of injury from internal parts!

- Do not turn the suction nozzle on the Kobold HD60 Hard Floor Nozzle further than it is designed to go.



CAUTION

Risk of injury from moving parts!

- Keep away from the moving parts on the Kobold HD60 Hard Floor Nozzle.

3.6.1 USE

1. Set the required power performance level (auto recommended).
2. To vacuum efficiently, move the device back and forth in an even motion.

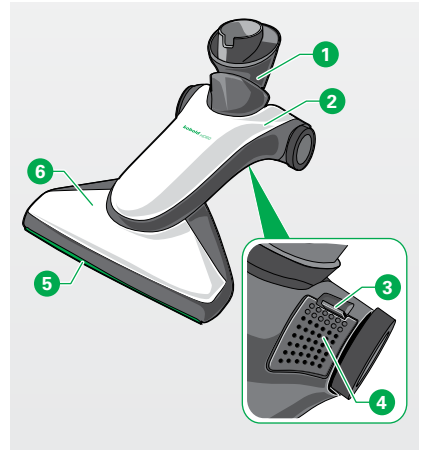

Legend

- | | |
|---|---|
| 1 | Pivot |
| 2 | Kobold HD60 Hard Floor Nozzle |
| 3 | Release catch on the inspection flap |
| 4 | Cover on the inspection flap – opening for removing blockages |
| 5 | Bristle plate (removable) |
| 6 | Suction nozzle |

3.7 KOBOLD ESS200 ELECTRIC SUCTION HOSE

The Kobold ESS200 Electric Suction Hose can be used in a number of ways in conjunction with the Kobold VK200 Upright Vacuum Cleaner.

3.7.1 ATTACHING THE KOBOLD ESS200 ELECTRIC SUCTION HOSE

1. Insert the port **1** of the Electric Suction Hose into the attachment socket of the Upright Vacuum Cleaner.

i The handle **2** of the Electric Suction Hose can be connected to the Flexo Nozzle, the Variable Nozzle, the Soft Nozzle or the accessory heads (e.g. the Electric Upholstery Brush).

i Using the Electric Upholstery Brush with the Electric Suction Hose is especially convenient as the Electric Upholstery Brush can be used in a more precise way.

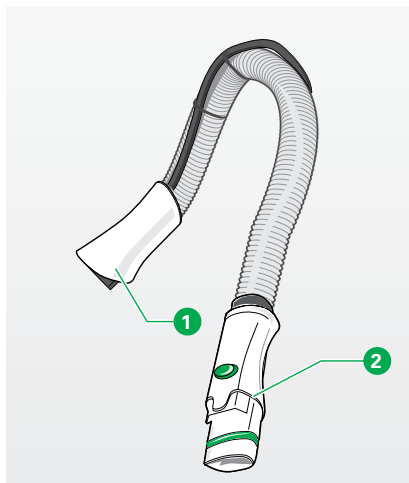

3.8 ADDITIONAL ACCESSORIES

By using the accessory set, you have a suitable solution for every task. This chapter provides an overview of the various nozzles and their applications. You can connect the accessories directly to the Kobold ESS200 Electric Suction Hose or to the Kobold TR15 Telescopic Tube.

3.8.1 KOBOLD TR15 TELESCOPIC TUBE

The Kobold TR15 Telescopic Tube makes it possible to work in areas that are high up in the room. You can easily vacuum spider webs, dust in corners or dusty curtain rods without having to use a ladder or step stool.



CAUTION

Risk of injury if the tube is not locked into position!

- Make sure the handle is locked before using the Kobold TR15 Telescopic Tube.



Used with the Flexo Nozzle, you can easily, conveniently and safely clean curtains or tapestry way up under the ceiling.



Thanks to the Soft Nozzle, you can now easily remove dust from ceiling lamps and chandeliers.

CONNECTING THE KOBOLD TR15 TELESCOPIC TUBE

To use the Telescopic Tube, the Electric Suction Hose must be connected to the Kobold VK200 Upright Vacuum Cleaner.

1. Insert the adaptor **1** of the Telescopic Tube into the handle of the Electric Suction Hose.

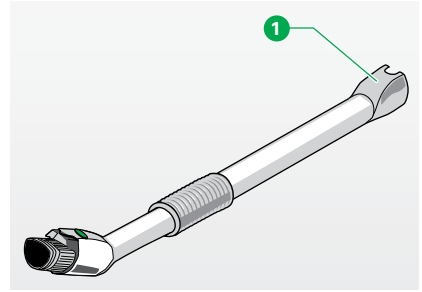

ADJUSTING THE LENGTH AND LOCKING

1. Turn the handle grip **2** in the direction marked “open” (identifiable through the symbol **3**) and adjust the Telescopic Tube to the desired length.
2. Turn the handle grip **2** in the direction marked “close” to lock the Telescopic Tube at this length.

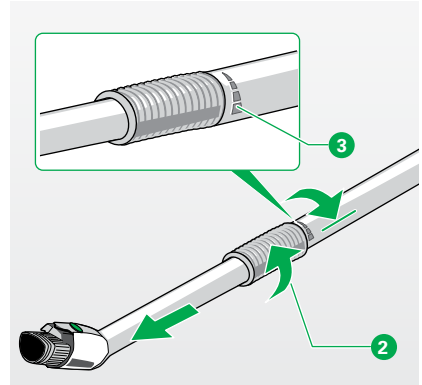

3.8.2 KOBOLD VD15 VARIABLE NOZZLE

The Kobold VD15 Variable Nozzle is extremely versatile. It has two attachments that can be used for different tasks.

1. Attach the socket **1** of the Variable Nozzle to the Electric Suction Hose.

The Variable Nozzle is provided with a joint **2** so that you are able to vacuum at an angle of 90 degrees. The extendable and flexible tip **3** allows you to reach even those corners and spots that are hard to reach or very narrow. In addition, you can use either the Drilling Dust Attachment or the Bristle Brush with the tip **3**.

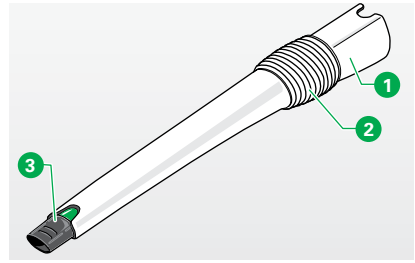

Legend

- | | |
|----------|------------------|
| 1 | Socket |
| 2 | Pivot |
| 3 | Tip (extendable) |
| 4 | Spring button |

ADJUSTING THE LENGTH

1. Pull out the tip **3**.
2. To slide the extension back in again, push the spring button **4** and then slide the tip back.

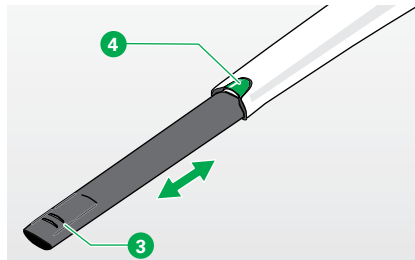

DRILLING DUST ATTACHMENT

The Drilling Dust Attachment allows you to collect drilling dust. You can drill a hole into the wall without having to worry about dust polluting your home.

1. Connect the Drilling Dust Attachment to the tip of the Kobold VD15 Variable Nozzle.
2. Switch on the Kobold VK200 Upright Vacuum Cleaner.
3. Place the Drilling Dust Attachment with the black seal against the wall.

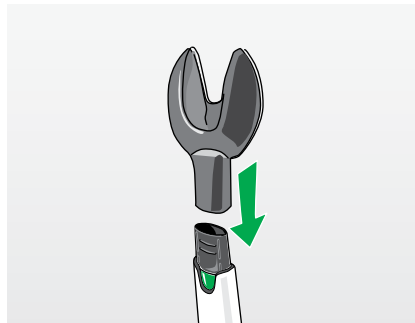

Due to the suction force of the Upright Vacuum Cleaner, the Drilling Dust Attachment will adhere to the wall by itself, provided it is completely even. This way you can freely use your hands to drill the hole.



Remove the Drilling Dust Attachment from the wall before switching off the Upright Vacuum Cleaner.

BRISTLE BRUSH

The Bristle Brush enables your Variable Nozzle to access even the smallest spaces and the tightest places. It is perfectly suited for vacuuming skirting boards and spaces between furniture and shelves.

1. To use it, put the Bristle Brush onto the tip of the Variable Nozzle.

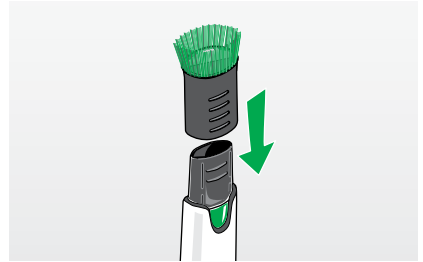

3.8.3 KOBOLD SD15 SOFT NOZZLE

The Kobold SD15 Soft Nozzle can either be used for vacuuming loose dust quickly and in a gentle manner, or to remove stubborn dirt. You can vary the bristle ring length and thereby adjust it to the type of surface.

The Soft Nozzle is especially well-suited to vacuum uneven surfaces such as keyboards, bookshelves, lampshades and all types of furniture surfaces.



1. Connect the Soft Nozzle to the Kobold ESS200 Electric Suction Hose.
2. By using the slider **1** you can adjust the bristle length.
3. In the case of light dust or sensitive objects, increase the bristle length. To do this, move the slider **1** forward.
4. Decrease the bristle length by pulling the slider **1** back if you wish to work on stubborn dirt or non-sensitive surfaces.

3.8.4 KOBOLD FD15 FLEXO NOZZLE

The Kobold FD15 Flexo Nozzle is a multi-purpose accessory that can be used on different surfaces.

In order to do this you can adjust the nozzle for the different areas of application.

Nozzle setting	for vacuuming
Flexo Nozzle complete	Furniture surfaces Stairs Walls, doors
Flexo Nozzle top part	Upholstery, fabrics, car seats
Flexo Nozzle folded	Joints, corners Between upholstery
Cleaning plate with- out bristle plate	Curtains, wall fabrics

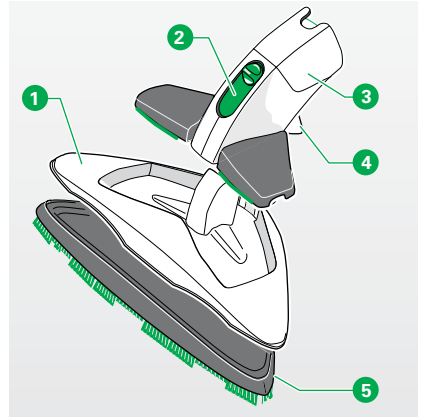

Legend

- | | |
|---|-----------------------|
| 1 | Cleaning plate |
| 2 | Slider |
| 3 | Flexo Nozzle top part |
| 4 | Release lever |
| 5 | Bristle plate |

3.8.5 KOBOLD FD15 FLEXO NOZZLE – COMPLETE

You can use the fully assembled Flexo Nozzle to vacuum furniture surfaces, stairs, walls or doors.

For more functions, only use individual parts of the Flexo Nozzle depending on the intended use.

3.8.6 KOBOLD FD15 FLEXO NOZZLE – TOP PART

You would like to vacuum dust, threads and hair from upholstery, fabrics or the inside of your car? Then remove the cleaning plate from the Flexo Nozzle.

1. To do this, push down the release lever 4 on the back of the attachment.
2. Slide the top part 3 of the Flexo Nozzle upwards and out.
3. Connect the Flexo Nozzle to the Kobold ESS200 Electric Suction Hose.

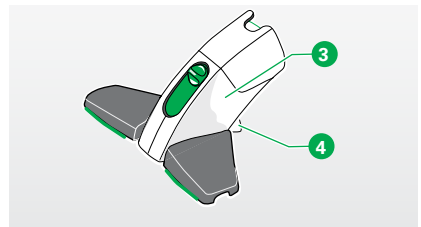

3.8.7 KOBOLD FD15 FLEXO NOZZLE – FOLDED

You would like to vacuum dust from joints, corners or between upholstery? Then remove the cleaning plate from the Flexo Nozzle.

1. To do this, push down the release lever ④ on the back of the attachment.
2. Slide the top part ③ of the Flexo Nozzle upwards and out.
3. Move the slider ② down so the wings of the Flexo Nozzle fold in.
4. Connect the Flexo Nozzle to the Electric Suction Hose.

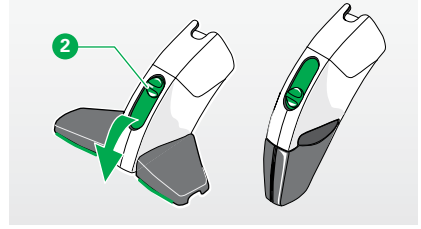

3.8.8 CLEANING PLATE

You would like to clean larger areas such as furniture surfaces or stairs, walls and doors? Then use the cleaning plate of the Flexo Nozzle.

1. Mount the cleaning plate ① on the top part ③ of the Flexo Nozzle.
2. Make sure all parts are correctly fitted.
3. Connect the Flexo Nozzle to the Electric Suction Hose.
4. To clean curtains or textile wall coverings, remove the bristle plate ⑤.
5. To remove the bristle plate ⑤, push up the bracket on the back of the attachment and remove the grey bristle plate with a quick pull.

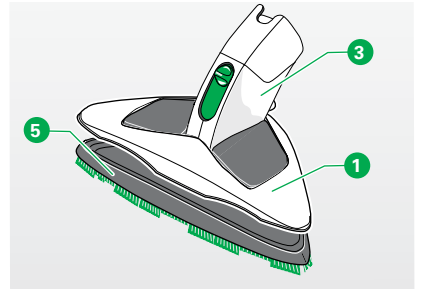

4 MAINTENANCE

Maintain your Kobold VK200 Upright Vacuum Cleaner regularly, so it can give you maximum performance and ease of use at all times.

In the following chapter you will learn how to maintain the different devices and accessory heads and how to replace parts.

Device/ accessories	Step	Time/frequency
Kobold VK200 Upright Vacuum Cleaner	Replace the 3in1 Premium Filter Bag FP200	When filter fill level indicator is entirely yellow
	Clean the motor protection filter	If dirty
	Replace the motor protection filter	If very dirty
	Clean the filter unit	If dirty
Kobold EB400 Automatic Electric Brush	Check and clean	Once a month
	Replace brushes	If worn
Kobold VF200 Carpet Freshener	Check and clean	After each use
	Replace brushes	If worn
Kobold SP600 SP600	Check and clean the sealing lip frames	If required
	Clean tank	If required
Kobold PB440 Electric Upholstery Brush	Vacuum	If dirty
Mattress Cleaning Set MP/MR440	Vacuum, wet clean with cloth if very dirty	After each use, only if very dirty
Additional accessories	Clean	If dirty

4.1 SPARE PARTS AND CONSUMABLES

You have purchased a quality product from Vorwerk. To keep you as satisfied in the future with your Vorwerk device as you were the first day, we recommend you take advantage of our reorder options for original care products and original consumables. Reordering is quick and easy:



From our Mail Order Hotline
(see chapter “8 Services” on page 116).



At our online shop at www.vorwerk.co.uk



4.2 MAINTAINING THE KOBOLD VK200 UPRIGHT VACUUM CLEANER

WARNING

Risk of electric shock!

- Always switch the device off before all retrofitting, cleaning and maintenance work and disconnect the mains plug from the socket.

4.2.1 CHANGING THE KOBOLD FP200 3IN1 PREMIUM FILTER BAG

CAUTION

Loss of suitability for allergy sufferers!

- Use original Kobold filters and filter bags only.
- Do not reuse spent filterbags.

NOTE

Risk of damage from improper use!

- Damp in the filter area can damage the device.
- Should the filter area be damp, make sure to dry it before using the device any further.
- Replace the 3in1 Premium Filter Bag FP200 and the Kobold VK200 motor protection filter.



Vorwerk 3in1 Premium Filter Bags can be purchased from the Mail Order Hotline (see chapter “8 Services” on page 116).



Vorwerk 3in1 Premium Filter Bags can also be obtained at our online shop at www.vorwerk.co.uk

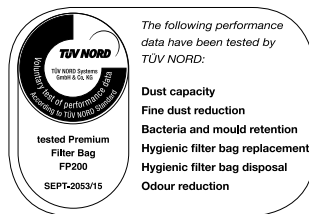

OPENING THE FILTER UNIT

i If you gently press and hold the filter cover with your thumb, it is easier to open.

1. Press the lower section of the opening latch on the filter cover with your thumb **1**.
2. Pull the opening latch towards you with your index finger **2**.
3. Fold open the filter cover **3**.

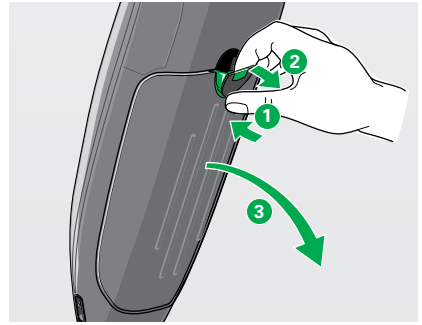

REMOVING A FULL 3IN1 PREMIUM FILTER BAG

1. Remove the 3in1 Premium Filter Bag and dispose of it in household waste.

INSERTING A NEW 3IN1 PREMIUM FILTER BAG

NOTE

Risk of damage from improper use!

- Avoid inserting the 3in1 Premium Filter Bag forcefully.

1. Insert a new, wrapped 3in1 Premium Filter Bag **3** into the filter unit **4** of your Kobold VK200 Upright Vacuum Cleaner.
2. Do **not** cut the package bands **5** on the 3in1 Premium Filter Bag. The Upright Vacuum Cleaner does this for you when you close it.
3. Make sure that the 3in1 Premium Filter Bag is fully inserted under the filter cover.

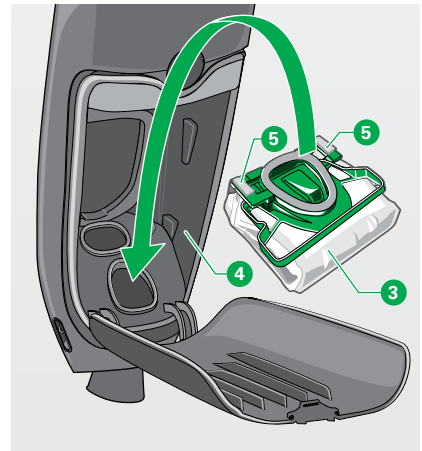

CLOSING THE FILTER UNIT

1. Push the filter cover of the filter unit shut until the cover latch engages.

i Resistance is felt when the cover locks as the cover will cut the package bands on the filter bag. No resistance will be felt if the cover is subsequently closed again, since the package bands have already been cut.

i The cover of the Upright Vacuum Cleaner filter unit will not close if the filter bag was not inserted or not inserted correctly.

1. If the filter cover can only be closed with difficulty, do not use force. Instead, ensure that the filter bag has been inserted correctly.

4.2.2 CLEANING AND/OR REPLACING THE KOBOLD VK200 MOTOR PROTECTION FILTER

The motor protection filter serves to protect your Upright Vacuum Cleaner from pollution. To ensure a long service life for your Upright Vacuum Cleaner, make sure to perform visual inspections and maintain the motor protection filter regularly.

The motor protection filter can be cleaned as many times as necessary. It must only be replaced if the 3in1 Premium Filter Bag has been damaged or if the motor protection filter is extremely dirty or gummed up.

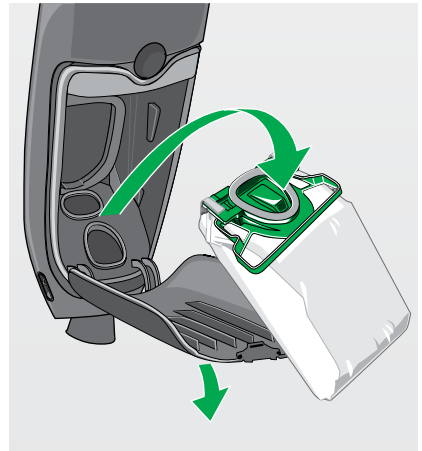

NOTE

Risk of damage from improper use!

- Only use the Upright Vacuum Cleaner with the motor protection filter inserted.

REMOVING THE MOTOR PROTECTION FILTER

The motor protection filter **1** is held in two places in the filter compartment of the Upright Vacuum Cleaner **2** and **3**.

1. Take hold of the flap **2** and pull it downwards while also pulling it towards you.
The locking mechanism disengages and the filter can be removed.

CLEANING THE MOTOR PROTECTION FILTER

NOTE

Risk of damage from improper use!

- Do not clean the Kobold VK200 motor protection filter with water or other fluids.

1. Vacuum the motor protection filter from both sides.

REPLACING THE MOTOR PROTECTION FILTER

1. If the motor protection filter has been damaged or is extremely dirty, insert a new one.



The Motor protection filter can be purchased from the Mail Order Hotline (see chapter "8 Services" on page 116).



Motor protection filters can also be obtained at our online shop at www.vorwerk.co.uk

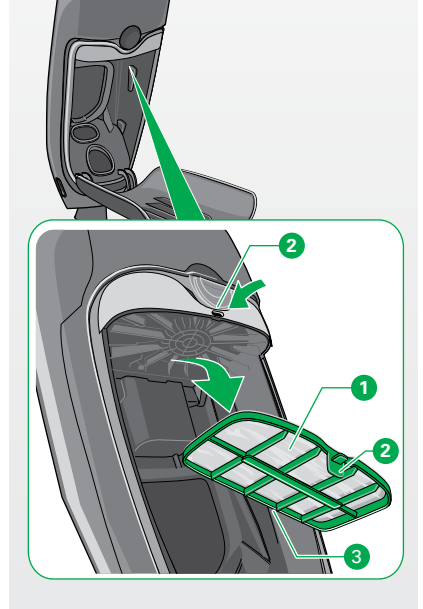

INSERTING THE MOTOR PROTECTION FILTER

1. Position the motor protection filter **1** behind the rib **3**.
2. Swing the filter up until it engages in the retainer **2**.
3. Close the filter unit.

NOTE

Risk of damage from improper use!

- Use the Upright Vacuum Cleaner only with the motor protection filter inserted.

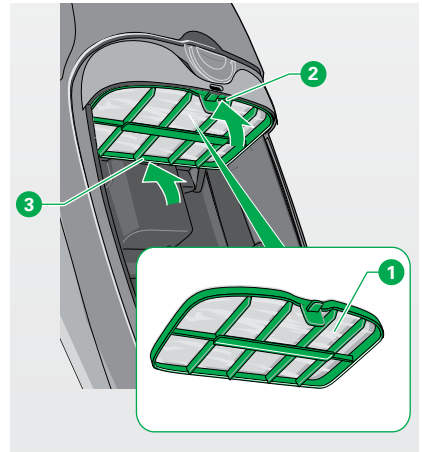

4.2.3 REMOVING THE POWER CORD FROM THE KOBOLD VK200 UPRIGHT VACUUM CLEANER

The power cord is designed to remain permanently connected to the device once it has been installed. However, you can remove the power cord if it is damaged and needs to be replaced.

WARNING

Risk of electric shock!

- Disconnect the plug from the mains socket before removing the power cord.

1. Release the plug from the Upright Vacuum Cleaner.
You can release the plug by pushing it up in the cable channel using the yellow collar **1** supplied. The tool is included with the replacement power cord.
2. Thread the plug through the cable channel **2** up and out of the handle grip **3**.
3. Dispose of the damaged power cord and insert a new, original Vorwerk power cord as described in the chapter “2.2 Mains connection” on page 19.

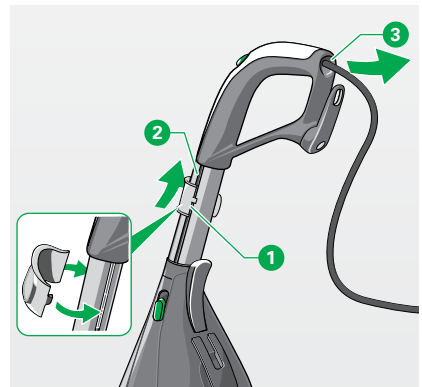

4.3 KOBOLD EB400 AUTOMATIC ELECTRIC BRUSH

WARNING

Risk of electric shock!

- Always switch the device off before all retrofitting, cleaning and maintenance work and disconnect the mains plug from the socket.

CAUTION

Pinching hazard!

- Stay clear of the moving parts on the Kobold EB400 Automatic Electric Brush.

4.3.1 CHECKING AND CLEANING

1. Check the underside every once in a while to prevent damage to the device and floor.
2. Perform visual inspections from time to time in order to detect defects or very dirty areas.
3. A dirty sensor  can simply be vacuumed. Do not insert any sharp objects into the sensor shaft.

4.3.2 TAKING OUT THE BRUSH TO CLEAN OR REPLACE IT

REMOVING THE ROLLER BRUSH

1. Place the Automatic Electric Brush upside down.
2. Unlock the floor plate **3** by pressing the locks **1** on both sides at the same time with your hands.
3. Take off the floor plate **3**.
4. First lift the green side of the roller brush **4** out of the Automatic Electric Brush and then pull the black side **5** off the axle.

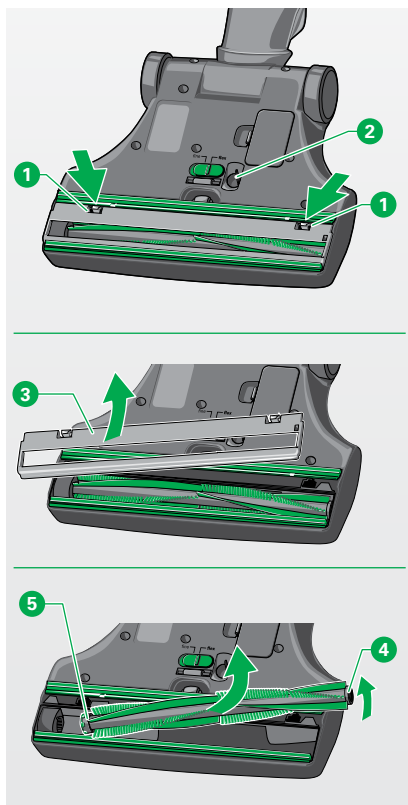

CLEANING THE ROLLER BRUSH

NOTE

Risk of damage to the device due to improper cleaning!

- Never wet clean the roller brush.
The roller brush is not dishwasher safe nor waterproof.

1. Remove lint, hair and other dirt from the roller brush.
2. Hair can be cut with scissors along the slots **1**.
3. Make sure that the green cap and the metal cup and ball bearing **2** of the roller brush underneath the cap are not loosened.

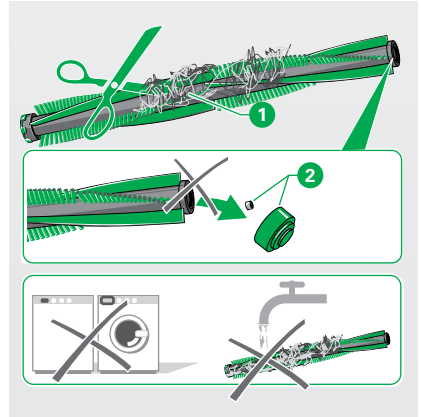

REINSTALLING THE ROLLER BRUSH

NOTE

Risk of damage from improper use!

- If the green cap has been removed, ensure that the small metal ball bearing fits correctly. Otherwise the bearing may be damaged.

1. Set the brush **1** with the black side onto the Torx® cam **2**. The green side is inserted on the opposite side **3**.
2. Place the floor plate **4** under the green sealing lip **5** and swivel it round to the middle of the device, until both locking bolts **6** audibly lock.



Roller brushes can be purchased from the Mail Order Hotline (see chapter "8 Services" on page 116).



Roller brushes can be purchased from the Mail Order Hotline (see chapter "8 Services" on page 116).

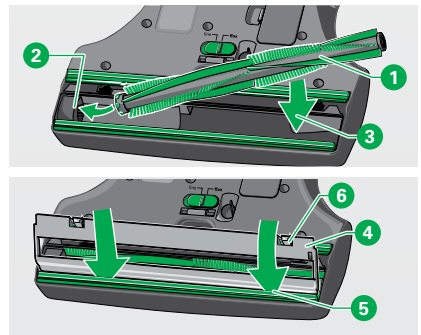

4.4 KOBOLD SP600

WARNING

Risk of electric shock!

- Always switch the device off before all retrofitting, cleaning and maintenance work. Before cleaning and maintenance work, also disconnect the mains plug from the socket.
- Never clean electrical connections with water, wet cleaning agents or the wet cleaning cloth.
- Never pour water over the device and never hold it under running water.

CAUTION

Pinching hazard!

- Keep away from the moving parts of the Kobold SP600.

4.4.1 CHECKING AND CLEANING THE SEALING LIP FRAMES

Check the condition of the sealing lips regularly; if required, remove fluff balls, hairs, etc.

REMOVING THE SEALING LIP FRAMES

In order to be able to clean the sealing lips thoroughly, the frames can be removed from the Kobold SP600.

1. Place the SP600 upside down. Make sure that the pivot is facing you.
2. Using gentle force, unlatch the left hand side of the sealing lip frame and pull it upwards to disengage ①.
3. Then slide it out of its mounting on the right hand side ②.
4. If required, rinse the sealing lip frames under running water.

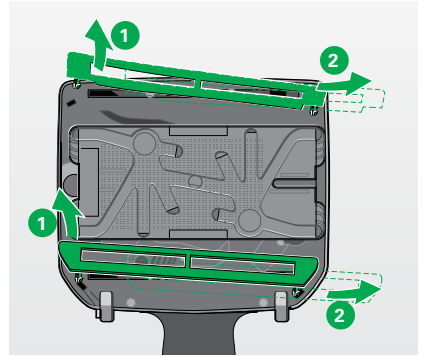

MOUNTING THE SEALING LIP FRAMES

Before reattaching the sealing lip frames in the device, they must have dried completely.

The two sealing lip frames are different in shape and have to be fitted on different sides. The end-to-end sealing lip of the frame must point inwards towards the cloth.

1. Insert the sealing lip frame on the right hand side first ①.
2. Then clip the left hand side into position ②. Make sure that the pin is inserted into the intended slot on the SP600.

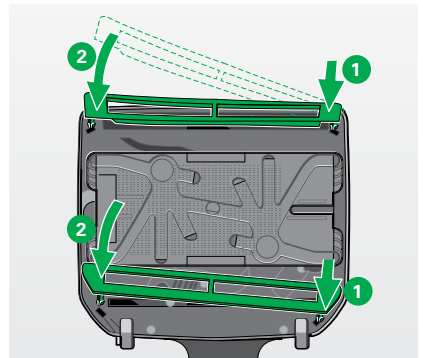

4.4.2 CLEANING THE TANK

Rinse the tank regularly with clean water. If needed, you can also rinse out the tank with a mild soap solution.

4.5 KOBOLD PB440 ELECTRIC UPHOLSTERY BRUSH AND KOBOLD MP440/MR440 MATTRESS CLEANING SET

WARNING

Risk of electric shock!

- Always switch the device off before all retrofitting, cleaning and maintenance work and disconnect the mains plug from the socket.
- Never clean the Kobold PB440 Electric Upholstery Brush or suction nozzle with water or damp cleaning agents.

4.5.1 KOBOLD PB440 ELECTRIC UPHOLSTERY BRUSH

1. Press the release lever and pull the Electric Upholstery Brush from the electric suction hose by the grip handles **1**.
2. Detach the suction nozzle.
3. Brush or wipe the device dry.
4. Check the suction nozzle every once in a while to ensure that no threads or hairs have coiled around the roller brushes.
5. If so, remove the suction nozzle.
6. Cut the threads or hairs with small scissors.
7. When inserting the suction nozzle, place the tips of the nozzle into the intended openings first.
8. Push the suction nozzle at the finger grooves **1** firmly against the device. Make sure that you can hear the suction nozzle engage.

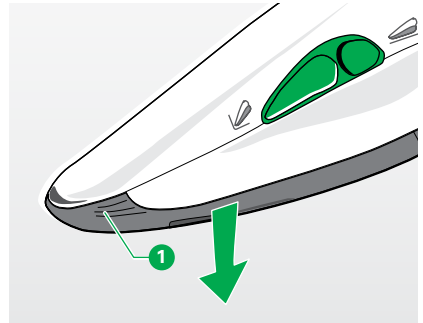

4.5.2 CLEANING THE KOBOLD MP440 MATTRESS FRESHENER

After the cleaning process, Lavenia residue may be stuck to the nubbed disc which impairs functionality during subsequent use.

1. Check the nubbed disc for residual dirt after every mattress cleaning.
2. Vacuum up the Lavenia residue with the Electric Suction Hose, Flexo Nozzle or Soft Nozzle.

The nubbed disc can also be removed in order to clean it under running water.

Proceed as follows:

1. Attach the Mattress Freshener **2** to the Electric Upholstery Brush **1**.
2. Turn the nubbed disc to release it (bayonet closure) **3**.
Note the symbol (lock) on the nubbed disc.
3. After cleaning and drying the nubbed disc, re-install it by turning it in the opposite direction **4**.

i The nubbed disc can only be removed if the Mattress Freshener is mounted on the Electric Upholstery Brush.

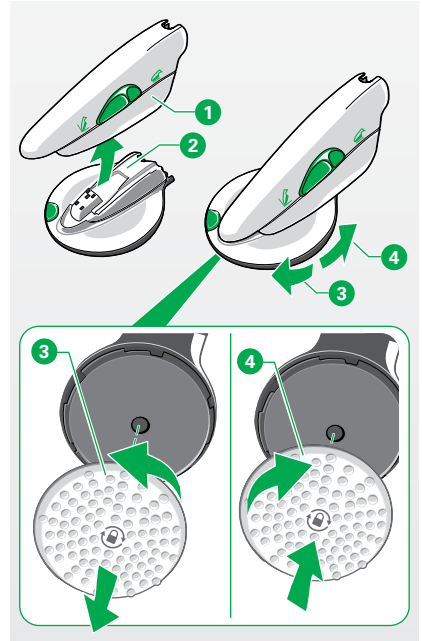

4.5.3 CLEANING THE KOBOLD MR440 MATTRESS VACUUMER

Lavenia may get stuck between the rubber beater bars of the Mattress Vacuumer.

1. Vacuum up the Lavenia residue with the Electric Suction Hose, Flexo Nozzle or Soft Nozzle. Never wet clean the entire device.

If it is very dirty, you can remove the beater unit from the Mattress Vacuumer for separate wet cleaning:

1. Attach the Mattress Vacuumer to the Electric Upholstery Brush **1**.
2. Remove the vibrating bars **2** by first pulling one side and then the other side of the holders outwards **3**.
3. Clean the vibrating bars under running water **4**.

4.6 ADDITIONAL ACCESSORIES

This chapter applies to the following accessories:

- Kobold HD60 Hard Floor Nozzle
- Kobold VD15 Variable Nozzle
- Kobold FD15 Flexo Nozzle
- Kobold SD15 Soft Nozzle

1. The accessory heads can be rinsed off under running water.
2. Allow the accessory heads to dry off before reusing them.
3. Clean the bristles of the Soft Nozzle with soap and lukewarm water.

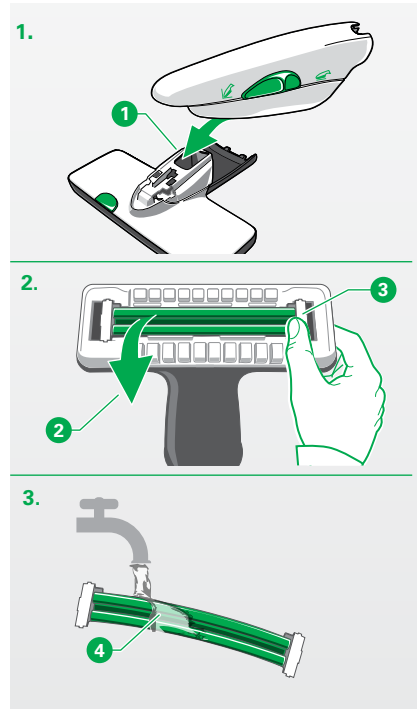

5 TROUBLESHOOTING

WARNING

Risk of electric shock and injury!

- Never perform repairs on your device yourself. Repairs to electric appliances may only be carried out by your authorised Vorwerk Customer Service Centre.
- Do not continue using the electrical accessory heads or the power cord if they become damaged.
- In case of damage, contact your Vorwerk Customer Service Centre.
- Should water get into the Kobold SP600 and/or the vacuum cleaner, ensure that both the Kobold vacuum cleaner and the Kobold SP600 are completely dry before using them again.

If your device is not working properly, it may be due to one of the following causes:

5.1 KOBOLD VK200 UPRIGHT VACUUM CLEANER

Fault	Possible causes and rectification
The device does not run.	<p>The power cord may not be properly engaged in the Upright Vacuum Cleaner.</p> <ul style="list-style-type: none">• Ensure that the power cord is inserted correctly (see chapter "2.2 Mains connection" on page 19).
The device doesn't run and the LEDs flash red.	<p>During initial commissioning: During initial set up the telescopic handle may not have been mounted correctly and so the electrical connection cannot be made between the power cord and device.</p> <ul style="list-style-type: none">• Pull out the mains plug.• Extend the handle again up to the stop and allow it to lock into place. <p>The device is already in use: Possibly the device has overheated.</p> <ul style="list-style-type: none">• Pull out the mains plug.• Let the device cool down and try again. <p>If the fault still continues to occur:</p> <ul style="list-style-type: none">• Contact the Vorwerk customer service (see chapter "8 Services" on page 116).

Fault**Possible causes and rectification**

After inserting a new, banded 3in1 Premium Filter Bag and switching on the device, all LED rows do not light up green.

Possibly the bands of the 3in1 Premium Filter Bag have not been severed.

- Open the filter cover and check whether the bands have been severed by the closure of the filter cover. If not, cut the bands by hand and close the cover again.

Filter cover has become detached from the device.

It is possible you have bumped against the opened cover.

Reinsert the cover:

- Set the filter cover onto the hinges of the device.
- Push the filter cover of the filter unit shut until the cover latch engages. If this is not possible, or if force would be required, check if the 3in1 Premium Filter Bag is correctly inserted.



The Upright Vacuum Cleaner releases an unpleasant odour.

The 3in1 Premium Filter Bag has lost its ability to retain odours even though it is not full.

- Replace the 3in1 Premium Filter Bag and insert a new Dovina fragrance chip.
 - Thoroughly clean the suction channel of the Upright Vacuum Cleaner and/or the connected device as well as the motor protection filter.
-

Fault	Possible causes and rectification
<p>The suction force of the Upright Vacuum Cleaner is declining.</p>	<p>The 3in1 Premium Filter Bag is probably full.</p> <ul style="list-style-type: none"> • Replace the 3in1 Premium Filter Bag. <p>The suction channel of the Upright Vacuum Cleaner or that of another connected device is blocked.</p> <ul style="list-style-type: none"> • Clean the suction channel of the Upright Vacuum Cleaner and/or that of the connected device. • Check whether the filter fill level indicator on your Upright Vacuum Cleaner lights up yellow. If so, replace the 3in1 Premium Filter Bag. <p>The motor protection filter is extremely dirty.</p> <ul style="list-style-type: none"> • Clean or replace the motor protection filter (see chapter "4.2.2 Cleaning and/or replacing the Kobold VK200 motor protection filter" on page 89).
<p>The Upright Vacuum Cleaner sets itself to a different power performance level and gets louder.</p>	<p>After prolonged use, with high ambient temperature or when the 3in1 Premium Filter Bag is full or blocked, the Upright Vacuum Cleaner will set itself to a different power performance level as a result of overheating so that the suction performance can no longer be regulated. In this case the valve will open automatically allowing air to flow directly into the inside of the motor.</p> <ul style="list-style-type: none"> • Check the suction channel and the connected accessory heads. • Remove any blockages and replace the 3in1 Premium Filter Bag if necessary. • Let the motor cool down. <p>This effect can also be the result of switching from hard floors to carpeting or generally when using power performance level auto (automatic suction power).</p>

5.2 KOBOLD EB400 AUTOMATIC ELECTRIC BRUSH

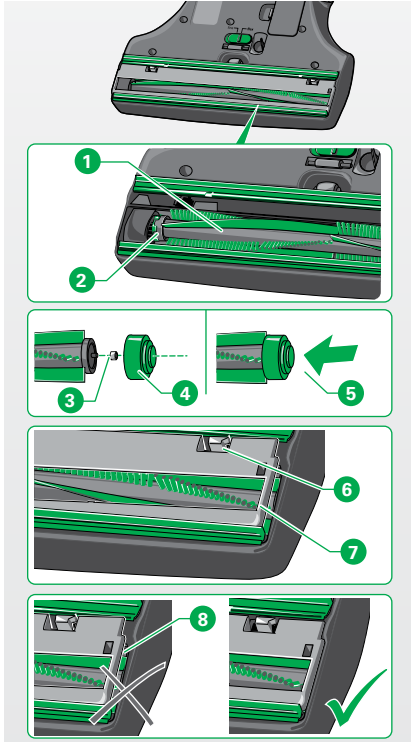
Fault	Possible causes and rectification
<p>The Automatic Electric Brush is too loud.</p> 	<p>The roller brush 1 is not mounted on the TORX® cam 2 of the gear mechanism.</p> <ul style="list-style-type: none"> • Check if the roller brush 1 is correctly inserted and mount it on the TORX® cam 2 of the gear mechanism if necessary. <p>The small bearing ball 3 of the cup and ball bearing is missing.</p> <ul style="list-style-type: none"> • Make sure that the bearing ball 3 is properly inserted. <p>The green cap of the cup and ball bearing 4 is not properly installed.</p> <ul style="list-style-type: none"> • Check if the green cap 4 is properly installed. If not then position the green cap correctly 5. <p>The floor plate is not properly engaged 8.</p> <ul style="list-style-type: none"> • Make sure that both locks (left and right) 6 engage audibly with a click during installation 7. <p>Maybe original Kobold accessories were not used, which can lead to bearing or motor damage.</p> <ul style="list-style-type: none"> • Use original Kobold roller brushes only. <p>An object might have got stuck in the area around the roller brushes.</p> <ul style="list-style-type: none"> • Remove the object.
<p>Threads have coiled around the roller brush.</p>	<ul style="list-style-type: none"> • Cut the threads as described in the chapter “Cleaning the roller brush” on page 94.
<p>The slider for switching between coarse materials and fine dust on the underside of the Automatic Electric Brush cannot be moved.</p>	<p>The Automatic Electric Brush is in hard floor mode.</p> <ul style="list-style-type: none"> • Make sure that the Automatic Electric Brush was properly switched off. Connect the automatic electronic brush with the vacuum cleaner and in the standby position (joint locked) switch them on and back off. <p>The Automatic Electric Brush is now in carpet mode.</p>

Fault**Possible causes and rectification**

The Automatic Electric Brush switches itself off, the operating display flashes red ①.

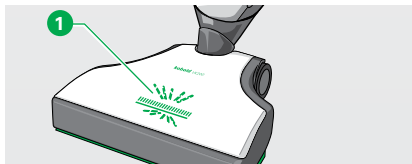

A vacuumed object is blocking the brush of the Automatic Electric Brush.

- Switch the device off and unplug the mains plug from the socket.
- Remove the object.

Threads block the brush of the Automatic Electric Brush.

- Cut the threads as described in the chapter “Cleaning the roller brush” on page 94.

The suction channel of the Automatic Electric Brush is blocked.

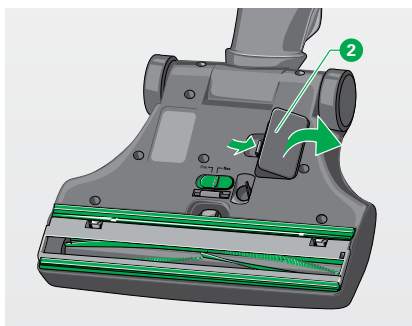

Switch the device off and unplug the mains plug from the socket.

- Open the inspection flap ② on the underside of the Automatic Electric Brush.
- Remove the blockage.
- To do this, use an appropriate object (e.g. screwdriver, crochet needle).

The Automatic Electric Brush is hard to push.

You might have set the power performance level too high.

- Use the main switch on the handle of the Upright Vacuum Cleaner to set the device to a lower power performance level or use power performance level auto in general.

The Automatic Electric Brush may be in manual operating mode.

- Switch the Upright Vacuum Cleaner off and back on again.

After replacing the roller brush, the device does not work any more.

The Automatic Electric Brush is not properly connected to the Upright Vacuum Cleaner.

- Check if the plug connection between the Automatic Electric Brush and the Upright Vacuum Cleaner is correctly engaged.

The roller brush is not correctly inserted.

- Mount the roller brush exactly on the TORX® cam of the drive axle.
-

5.3 KOBOLD VF200 CARPET FRESHENER

Fault	Possible causes and rectification
<p>The cleaning performance of the Carpet Freshener is significantly reduced.</p>	<p>There may be cleaning residue from a previous carpet cleaning in the device, preventing proper functioning of the Carpet Freshener.</p> <ul style="list-style-type: none">• Clean the dosage hopper and brush as described in the chapter "3.2.7 Cleaning the Kobold VF200 Carpet Freshener after use" on page 45. <p>The dosage of Kobosan Active may not have been sufficient, or the properties of your carpet make it unsuitable for cleaning with the Carpet Freshener.</p> <ul style="list-style-type: none">• Check whether your carpet can be cleaned with the Carpet Freshener.• Check whether the dosage of Kobosan Active was sufficient as specified in the chapter "3.2.1 Carpet cleaning with the Kobold VF200 Carpet Freshener" on page 40.
<p>After brush cleaning, the device does not work any more.</p>	<p>The Carpet Freshener is not properly connected to the Upright Vacuum Cleaner.</p> <ul style="list-style-type: none">• Check if the plug connection between the Carpet Freshener and the Upright Vacuum Cleaner is correctly engaged 3. <p>The foot switch was not adequately pressed 1 to start dosage of the Kobosan Active.</p> <ul style="list-style-type: none">• Operate Kobosan Active dosage with the foot switch 2.

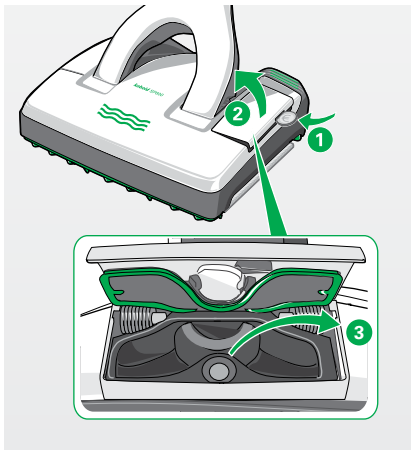

5.4 KOBOLD SP600

Fault	Possible causes and rectification
<p>The SP600 switches itself off and the LED waves are lit up red.</p>	<p>It is possible that the motor is overstrained.</p> <ul style="list-style-type: none">• Switch off the vacuum cleaner.• Let the motor cool down.• Switch the vacuum cleaner back on.
<p>The vacuum cleaner switches itself off and the SP600 switches off simultaneously.</p> <p>The LED waves are flashing red and the inspection flap comes open.</p>	<p>Moisture has been sucked in.</p> <ul style="list-style-type: none">• Switch off the vacuum cleaner.• Using a kitchen towel, dry the area of the suction channel that is exposed by the inspection flap.• After the device has dried completely, switch on the vacuum cleaner and close the secondary air flap of the SP600.• It is possible that this step will need to be repeated several times.
<p>When switching on the vacuum cleaner, the LED waves light up red.</p>	<p>Moisture was absorbed when the device was last used.</p> <ul style="list-style-type: none">• Switch off the vacuum cleaner.• Close the flap.• Then switch the vacuum cleaner back on again.
<p>The suction channel of the SP600 is blocked.</p> 	<ul style="list-style-type: none">• Switch off the vacuum cleaner.• Open the inspection flap on the left hand side of the device. This can be done by inserting a coin into the groove ①.• The magnetic latch on the inspection flap comes open ②. You can now clearly see inside the suction channel.• Remove any objects that are blocking the suction channel ③. To do this, use an appropriate object (e.g. screwdriver, crochet needle).• Close the inspection flap again by pressing it shut. The magnetic latch on the inspection flap will click into place and it is now firmly closed.• Also check whether the suction openings between the sealing lips are clear. If necessary, shake out any objects inside.
<p>The joint connector of the SP600 is blocked.</p>	<ul style="list-style-type: none">• Remove the blockage with a suitable tool (e.g. screw driver, crochet hook).

Fault	Possible causes and rectification
The SP600 is making unusual noises.	<p>It is possible that the device has not been closed correctly or that the cloth holder has not been mounted correctly.</p> <ul style="list-style-type: none"> • Check whether the inspection flap is closed correctly and close it if not. • Check the cloth holder is correctly inserted and the green latch is engaged. <p>It is possible that the tank is not correctly installed.</p> <ul style="list-style-type: none"> • Switch off the vacuum cleaner. • Install the tank as described in the chapter “Removing, filling and inserting the tank” on page 57. • Then switch the vacuum cleaner back on again.
The secondary air flap does not close/does not remain closed.	<p>It is possible that the holding magnet is dirty.</p> <ul style="list-style-type: none"> • Switch off the vacuum cleaner. • Clean the surface of the magnet. <p>It is possible that the suction channel is still wet.</p> <ul style="list-style-type: none"> • Switch off the vacuum cleaner. • Using a kitchen towel, dry the area of the suction channel that is exposed by the inspection flap. • Let the suction channel dry before continuing.
The SP600 is swivelling excessively.	<p>The cleaning cloth is not fixed properly.</p> <ul style="list-style-type: none"> • Check whether the cleaning cloth is straight and firmly fixed on the cloth holder. • Check whether the green nose of the cleaning cloth has been correctly and fully pushed in. <p>The cloth holder is not inserted correctly.</p> <ul style="list-style-type: none"> • Check whether the cloth holder has attached itself correctly to the SP600. <p>It is possible that original cleaning cloths were not used.</p> <ul style="list-style-type: none"> • Only use original Kobold cleaning cloths. • Use the Kobold MF600 Universal cleaning cloth on rough surfaces.

Fault**Possible causes and rectification**

The SP600 causes streaks/marks on the floor.

It is possible that the sealing lip frames are dirty and jammed.

- Remove the front sealing lip frame as described in the chapter "4.4.1 Checking and cleaning the sealing lip frames" on page 96.

It is possible that the cleaning cloth is soiled excessively.

- Change the cleaning cloth as described in the chapter "Removing and replacing the Kobold MF600 cleaning cloth" on page 68.

The vacuuming result of the SP600 is insufficient.

It is possible that the sealing lip frames are dirty and jammed.

- Remove and clean the sealing lip frames as described in the chapter "4.4.1 Checking and cleaning the sealing lip frames" on page 96.
- Also check whether the suction openings between the sealing lips are clear from underneath. If necessary, shake out any objects inside.

It is possible that the cleaning cloth has been fixed in a diagonal position on the cloth holder and collides with the sealing lip frames.

- Check whether the cleaning cloth is evenly fixed on the cloth holder.

It is possible that the suction channel is blocked.

- Open the inspection flap on the left hand side of the SP600 to clear any blockages. This can be done by inserting a coin into the groove **1**.

The magnetic latch on the inspection flap comes open **2**. You can now clearly see inside the suction channel.

- Remove any objects that are blocking the suction channel **3**. To do this, use an appropriate object (e.g. screwdriver, crochet needle).
 - Close the inspection flap again by pressing it shut. The magnetic latch on the inspection flap will click into place and it is now firmly closed.
-

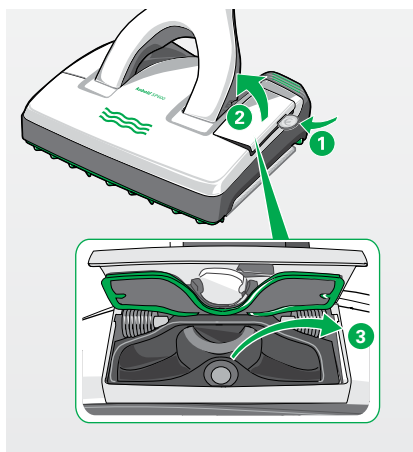

Fault	Possible causes and rectification
<p>The cleaning performance of the SP600 worsens.</p>	<p>It is possible that the cleaning cloth is soiled excessively.</p> <ul style="list-style-type: none"> • Change the cleaning cloth as described in the chapter “Removing and replacing the Kobold MF600 cleaning cloth” on page 68. <p>It is possible that the cleaning cloth is too dry.</p> <ul style="list-style-type: none"> • Check the LED waves on the SP600. If they are lit up yellow, you need to fill the tank as described in the chapter “Removing, filling and inserting the tank” on page 57. • Apply moisture to the cleaning cloth using the function key as described in the chapter “Single application of moisture to a dry cloth” on page 63. • You can also increase the moisture setting, if required, using the function key as described in the chapter “3.4.8 Automatic application of moisture and dry mode” on page 61.
<p>Streaks are forming.</p>	<p>It is possible that the cleaning cloth was not washed prior to first use.</p> <ul style="list-style-type: none"> • Wash the cleaning cloth prior to first use as described in “Cleaning the Kobold MF600 cleaning cloths” on page 69. <p>It is possible that the cleaning agent has been overdosed.</p> <ul style="list-style-type: none"> • Repeat the cleaning process with a new cleaning cloth and clean water. <p>It is possible that there are residual quantities of old care products and cleaning agents on the floor.</p> <ul style="list-style-type: none"> • Repeat the cleaning process until it improves; a basic cleaning might be required. <p>It is possible that the cleaning cloth is soiled excessively.</p> <ul style="list-style-type: none"> • Change the cleaning cloth as described in the chapter on “Removing and replacing the Kobold MF600 cleaning cloth” on page 68. <p>The moisture film does not dry evenly.</p> <ul style="list-style-type: none"> • Go over the floor again using the SP600 in dry mode with a dry cleaning cloth to remove residual liquid.

Fault	Possible causes and rectification
The SP600 cleans edges insufficiently.	<p data-bbox="479 140 1059 194">It is possible that the cleaning cloth has not been fixed properly.</p> <ul data-bbox="479 210 1059 264" style="list-style-type: none"> <li data-bbox="479 210 1059 264">• Check whether the cleaning cloth is straight and firmly fixed on the cloth holder. <p data-bbox="479 280 1059 335">It is possible that the cleaning cloth was not washed prior to first use.</p> <ul data-bbox="479 351 1059 430" style="list-style-type: none"> <li data-bbox="479 351 1059 430">• Wash the cleaning cloth prior to first use as described in the chapter on “Cleaning the Kobold MF600 cleaning cloths” on page 69. <p data-bbox="479 446 1059 475">It is possible that the cleaning cloth is too dry.</p> <ul data-bbox="479 491 1059 801" style="list-style-type: none"> <li data-bbox="479 491 1059 603">• Check the LED wave symbol on the SP600. If they are lit up yellow, you need to fill the tank as described in the chapter on “Removing, filling and inserting the tank” on page 57. <li data-bbox="479 619 1059 689">• Apply moisture to the cleaning cloth using the function key as described in the chapter on “Single application of moisture to a dry cloth” on page 63. <li data-bbox="479 705 1059 801">• You can also increase the moisture setting, if required, using the function key as described in the chapter on “3.4.8 Automatic application of moisture and dry mode” on page 61.
A dirt film remains on the floor.	<p data-bbox="479 817 1059 871">It is possible that the cleaning cloth is soiled excessively.</p> <ul data-bbox="479 887 1059 965" style="list-style-type: none"> <li data-bbox="479 887 1059 965">• Change the cleaning cloth as described in the chapter on “Removing and replacing the Kobold MF600 cleaning cloth” on page 68.

Fault	Possible causes and rectification
Stain removal is insufficient.	<p>It is possible that the cleaning cloth is soiled excessively.</p> <ul style="list-style-type: none"> • Change the cleaning cloth as described in the chapter “Cleaning the Kobold MF600 cleaning cloths” on page 69. <p>It is possible that the cleaning cloth is too dry.</p> <ul style="list-style-type: none"> • Check the LED wave symbol on the SP600. If they are lit up yellow, you need to fill the tank as described in the chapter “Removing, filling and inserting the tank” on page 57. • Apply moisture to the cleaning cloth using the function key as described in the chapter “Single application of moisture to a dry cloth” on page 63. • You can also increase the moisture setting, if required, using the function key as described in the chapter “3.4.8 Automatic application of moisture and dry mode” on page 61.
After cleaning, the floor looks tarnished.	<p>It is possible that there are residual quantities of old care products and cleaning agents on the floor.</p> <ul style="list-style-type: none"> • First let the floor dry completely and, if there is still no change, use a dry cloth to remove the residual layer of polish. • Alternatively, use the MF600 Dry cleaning cloth to remove any residual quantities of old care products and cleaning agents. • Repeat the cleaning process, and change the cloth if required until it improves. • If there is no improvement, carry out a thorough clean of the floor before continuing to work with the SP600.
The moisture film is uneven.	<p>It is possible that the tank is empty.</p> <ul style="list-style-type: none"> • Check the LED waves on the SP600. If they are lit up yellow, you need to fill the tank as described in the chapter “Removing, filling and inserting the tank” on page 57. • Moisten the cleaning cloth by pressing the function key as described in the chapter “3.4.8 Automatic application of moisture and dry mode” on page 61 before continuing.

Fault	Possible causes and rectification
The floor is getting too wet.	<ul style="list-style-type: none"> • Set the SP600 to dry mode, as described in the chapter “3.4.8 Automatic application of moisture and dry mode” on page 61. • Continue working without the automatic moistening function for the time being until the floor appears to be drying. • Then set the SP600 to moisture setting 1, as described in the chapter “3.4.8 Automatic application of moisture and dry mode” on page 61.

5.5 KOBOLD PB440 ELECTRIC UPHOLSTERY BRUSH

Fault	Possible causes and rectification
The Electric Upholstery Brush will not operate.	<p>The Electric Upholstery Brush was connected to the TR15 Telescopic Tube or a Suction Hose without the power cord.</p> <ul style="list-style-type: none"> • Connect the Electric Upholstery Brush to an Electric Suction Hose. <p>The Upright Vacuum Cleaner is not switched on.</p> <ul style="list-style-type: none"> • Switch on the device.
The bristles of the Electric Upholstery Brush are deformed or matted.	<p>Fringes or fabrics were sucked in and pulled out again.</p> <ul style="list-style-type: none"> • Replace the suction nozzle.
The brushes of the Electric Upholstery Brush no longer rotate.	<p>The Upright Vacuum Cleaner is not switched on.</p> <ul style="list-style-type: none"> • Switch on the device. <p>The suction nozzle is not correctly inserted.</p> <ul style="list-style-type: none"> • Make sure to engage the suction nozzle properly. <p>Something was sucked in that is blocking the brushes.</p> <ul style="list-style-type: none"> • Switch the device off and unplug the mains plug from the socket. • Remove the object that was sucked in. • Switch the device back on.

5.6 KOBOLD FD15 FLE XO NOZZLE

Fault

The wings of the Flexo Nozzle are unhooked.

Possible causes and rectification

- Reattach the wings.

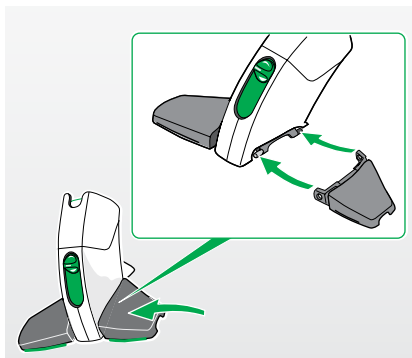

If the fault cannot be rectified, please contact Vorwerk's customer service department (see chapter "8 Services" on page 116).

6 DISPOSAL AND ENVIRONMENTAL PROTECTION

6.1 DISPOSAL OF THE DEVICE



The law states that as owner of an electrical or electronic device you are not allowed (under DIRECTIVE 2012/19/EU OF THE EUROPEAN PARLIAMENT AND OF THE COUNCIL of 4th July 2012 on waste electric and electronic equipment, and the reformed German Electrical and Electronic Equipment Act of 20 October 2015) to dispose of this device or its electrical/electronic accessories via unsorted domestic waste.

- Instead, please use the free collection centres intended for this purpose.
- Contact your local council for information.

6.2 DISPOSING OF THE PACKAGING

The packaging is an important part of our product: it protects our devices from damage during transportation and reduces the risk of a device fault. For this reason, we cannot avoid using packaging. If you need to return or send in your device during the warranty period, or after, to the service or customer service department, the original packaging is the best protection against damages in transit.

If you nevertheless wish to dispose of the packaging, you can do this at any time and without limitation via your local council facilities (waste paper skip, yellow skip, recycling depot, waste paper collection etc.). Vorwerk commissions authorised licensors for this. In case of queries please contact your respective Service centre (see chapter “8 Services” on page 116).

6.3 INFORMATION ON ENVIRONMENTAL PROTECTION

Preserving nature and protecting the environment: At Vorwerk, environmental protection is an important company objective.

6.3.1 LESS PACKAGING

We use only environmentally friendly material, which is recycled if disposed of correctly. We are actively involved in cutting back on waste packaging during the development stages and are committed to its disposal and recycling.

6.3.2 SAVING ENERGY

Vorwerk products protect the environment: They only use a small amount of energy with high suction performance.

6.3.3 ENVIRONMENTALLY FRIENDLY PRODUCTION

We attach a great deal of importance to environmental protection when manufacturing our products. We use recyclable plastics and colours. We deliberately avoid using polluting flame retardants.

For our filterbags we use solvent-free adhesives, unbleached paper and non-hazardous plastic. Our instruction manuals are made from sustainably managed forests and are bleached without chlorine.

6.3.4 REUSABLE MATERIAL

The material for our products can nearly be completely recycled. We largely avoid using PVC. When manufacturing our products, we use “sorted” materials:

The substances used can later be separated accordingly at modern facilities without much energy expenditure. To make them even easier for recycling, we have labelled most of our plastic components.

7 WARRANTY

Any warranty services can be found in the order note or purchase contract.

8 SERVICES



Either in person with your customer representative
or at the Customer Services



www.vorwerk.co.uk

9 TECHNICAL SPECIFICATIONS

Kobold VK200-1 Upright Vacuum Cleaner

Safety signs



Housing	High-grade recyclable thermoformed plastic			
Motor	Maintenance-free reluctance motor with ball bearings and electronic performance control at a nominal rotation speed of 60,000 RPM			
Blower	Single-stage radial fan			
Voltage	220–240 volts alternating current 50/60 Hertz			
Nominal output	700 watts (max. 1100 watts nominal output with auxiliary equipment)			
Electrical power output without accessory head or nozzle	Level auto	Level soft	Level med	Level max
	100–450 watts	50 watts	300 watts	450–700 watts
Radius of action	Min. 7 m (according to DIN EN 60312-1)			
Max. underpressure	160 hPa (according to DIN EN 60312-1 / at 700 watts)			
Max. air quantity	44.5 l/s (according to DIN EN 60312-1 / at 700 watts)			
Max. suction power	280 watts with clean filter (according to DIN EN 60312-1 / at 700 watts)			
Max. degree of efficiency	40% (according to DIN EN 60312-1 / at 700 watts)			
Filter Bag volume	2.2 l (according to DIN EN 60312-1)			
Dust emission	Approx. 0.001 % (according to DIN EN 60312-1)			
Weight	Approx. 3 kg (without accessories)			
Dimensions	Height approx. 15 cm; width approx. 21 cm; length approx. 85/109 cm			
Noise emission	78 dB(A) re 1pW sound power level with Kobold EB400 according to EN 60704-2-1			

Kobold EB400-1 Automatic Electric Brush

Safety signs



Housing	High-grade recyclable thermoformed plastic
Motor	maintenance-free DC motor and maintenance-free toothed belt drive
Voltage	220–240 volts alternating current 50/60 Hertz
Nominal output	50 watts (only for use in combination with Kobold vacuum cleaners)
Brush	Exchangeable and replaceable rotating brush
Working width	300 mm
Carpet mode	1860-2500 RPM
Hard floor mode	800 RPM
Weight	Approx. 1.8 kg
Dimensions	Height: approx. 7 cm (with horizontal joint) Width: approx. 30 cm Length: approx. 35 cm (with horizontal joint)
Noise emission	78 dB(A) re 1pW sound power level with Kobold VK200 according to EN 60704-2-1

Kobold VF200 Carpet Freshener

Safety signs



Housing High-grade recyclable thermoformed plastic

Working width Device width in the vicinity of the brushes area approx. 310 mm

Rotational speed of the brush Approx. 2500 RPM

Weight Approx. 1.8 kg

Dimensions Height: approx. 11 cm (with horizontal joint)
Width: approx. 35 cm
Length: approx. 35 cm (with horizontal joint)

Noise emission 87 dB(A) re 1pW sound power level with Kobold VK200 according to EN 60704-2-1

Kobold SP600-1 SP600

Safety signs



Housing

High-quality, recyclable plastic

Gear unit

1st stage – spur / worm gear
2nd stage – maintenance-free toothed belt drive 1350 RPM

Motor

maintenance-free DC brush motor

Voltage

220–240 volts alternating current 50/60 Hertz

Nominal output

100 watts (only for use in combination with Kobold vacuum cleaners)

Weight

Approx. 3.5 kg

Dimensions

Height: approx. 10 cm (with horizontal joint)
Width: approx. 31 cm
Length: approx. 37 cm (with horizontal joint)

Tank volume

Approx. 260 ml

Noise emission

87 dB(A) re 1pW sound power level with Kobold VK200 Upright Vacuum Cleaner based on EN 60704-2-1 on smooth tiles

Kobold PB440-1 Electric Upholstery Brush

Safety signs



Housing High-quality plastic with detachable suction nozzle made of shatter-proof polyamide

Motor maintenance-free DC motor with direct transmission

Brush mechanics 2 counter-rotating roller brushes with approx. 4000 RPM, maintenance-free bearings

Voltage 220–240 volts alternating current 50/60 Hertz

Nominal output 50 watts

Weight Approx. 600 g (Kobold PB440 Electric Upholstery Brush)

Approx. 440 g (Kobold MP440 Mattress Freshener)

Approx. 300 g (Kobold MR440 Mattress Vacuumer)

Dimensions Kobold PB440 Electric Upholstery Brush:

Height: approx. 11 cm

Width: approx. 8 cm

Length: approx. 25 cm

Kobold MP440 Mattress Freshener:

Height: approx. 6 cm

Width: approx. 18 cm

Length: approx. 20 cm

Kobold MR440 Mattress Vacuumer:

Height: approx. 5.5 cm

Width: approx. 25 cm

Length: approx. 20 cm

Noise emission 82 dB(A) re1 pW sound power level with Kobold VK200 Upright Vacuum Cleaner based on EN 60704-2-1 on upholstery fabric

85 dB(A) re1 pW sound power level with Kobold VK200 Upright Vacuum Cleaner and Mattress Freshener MP440 based on EN 60704-2-1 on mattress

84 dB(A) re1 pW sound power level with Kobold VK200 Upright Vacuum Cleaner and Mattress Vacuumer MR440 based on EN 60704-2-1 on mattress

9.1 MANUFACTURER

Vorwerk Elektrowerke GmbH & Co. KG

Mühlenweg 17-37

42270 Wuppertal

Deutschland

kobold
VK200

